

60 años
fabricando

2020



alfa®

rubinett® | idrop® | alfelec® | alfaloc® | alfa**green**®

alfa®

ferretería



FABRICANDO DESDE 1957
MARCA LÍDER EN URBANIZACIÓN
Y PLOMERÍA





rubinett

Monomandos	2
Juegos de Baño	6
Regaderas	8
Monomandos de Cocina	9
Tarjas	10

alfa

BAÑO

Mezcladoras	12
Juegos de Baño	19
Regaderas	21
Manerales	23
Cespoles	25
Muebles para baño	28
Accesorios	29
Fléxicos	32
Línea institucional	34

COCINA

Mezcladoras	35
Tarjas	42

Cespoles y Contras

46

BOMBAS

49

JARDÍN

53

CINTAS

55

LONAS

56

VÁLVULAS

57

CONEXIONES

Cobre	59
PPR	64
PPR Rojo (nuevo)	66
Ced40	67
Ced80	70
CPVC	71
Galvanizado	74
Gas	76

alfagreen

Calentadores	82
COLADERAS	83
REFACCIONES	84

ídrop

Mezcladoras	92
-------------	----

alfaloc

Pomos y Cerraduras	95
Candados	98
Accesorios	99

alfelec

Focos	102
Reflectores	105
Lámparas	106
Placas	107
Artefactos	116





rubinett[®]

MONOMANDO PARA LAVABO



Cuerpo de acero inoxidable 304

con aireador mate

CLAVE	C/M	MEDIDA
XK-MNN-BR1	1/20	18 cm

MONOMANDO PARA LAVABO



Cuerpo de acero inoxidable 304

con aireador satinado

CLAVE	C/M	MEDIDA
XK-MNS-BR1	1/10	18 cm

MONOMANDO PARA LAVABO



Cuerpo de latón sólido

con aireador cromado

CLAVE	C/M	MEDIDA
XK-MN-BR1	1/10	18 cm

MONOMANDO PARA FREGADERO



Cuerpo de acero inoxidable 304

con aireador mate

CLAVE	C/M	MEDIDA
XK-MNN-CC1	1/20	37cm

MONOMANDO PARA FREGADERO



Cuerpo acero inoxidable 304

con aireador satinado

CLAVE	C/M	MEDIDA
XK-MN-CSS1	1/20	37cm

MONOMANDO PARA FREGADERO



Cuerpo de latón

con aireador cromado

CLAVE	C/M	MEDIDA
XK-MN-CR1	1/10	37cm

MONOMANDO PARA REGADERA

- Con válvula.



Cubrimiento Acero inoxidable

Cuerpo de latón sólido

mate

CLAVE	C/M	DETALLES
XK-MN-RN01	1/10	REDONDO

MONOMANDO PARA REGADERA

- Con válvula.



Cubrimiento Acero inoxidable

Cuerpo de latón sólido

satinado

CLAVE	C/M	DETALLES
XK-MN-RS01	1/12	REDONDO

MONOMANDO PARA REGADERA

- Con válvula.



Cubrimiento Acero inoxidable

Cuerpo latón sólido

cromado

CLAVE	C/M	DETALLES
XK-MN-R01	1/10	REDONDO

MONOMANDO PARA LAVABO



con aireador ● mate

CLAVE	C/M	MEDIDA
XK-MNN-BC1	1/20	17 cm

MONOMANDO PARA LAVABO



● satinado

CLAVE	C/M	MEDIDA
XK-MN-BC3	1/20	19 cm

MONOMANDO PARA LAVABO



● cromado

CLAVE	C/M	MEDIDA
XK-MN-BC2	1/20	16 cm

MONOMANDO PARA FREGADERO



con aireador ● mate

CLAVE	C/M	MEDIDA
XK-MNN-CA1	1/20	34cm

MONOMANDO PARA FREGADERO



con aireador ● satinado

CLAVE	C/M	MEDIDA
XK-MNS-CA1	1/10	34cm

PROX. MAY

MONOMANDO PARA FREGADERO



con aireador ● cromado

CLAVE	C/M	MEDIDA
XK-MN-CA1	1/10	34cm

PROX. MAY

MONOMANDO PARA REGADERA

- Con válvula.



● mate

CLAVE	C/M	DETALLES
XK-MN-RN02	1/10	CUADRADO

MONOMANDO PARA REGADERA

- Con válvula.



● satinado

CLAVE	C/M	DETALLES
XK-MN-RS02	1/12	CUADRADO

PROX. MAY

MONOMANDO PARA REGADERA

- Con válvula.



● cromado

CLAVE	C/M	DETALLES
XK-MN-R02	1/10	CUADRADO

MONOMANDO PARA LAVABO

rubinett
NUEVO



Maneral metálico

Cuerpo de latón

dorado

PROX.
MAY

CLAVE	C/M	MEDIDA
XK-MND-T01	1/10	17 cm

MONOMANDO PARA LAVABO

rubinett
NUEVO



Maneral metálico

Cuerpo de latón

gun metal

PROX.
MAY

CLAVE	C/M	MEDIDA
XK-MNG-T01	1/10	17 cm

MONOMANDO PARA LAVABO

rubinett
NUEVO



Maneral metálico

Cuerpo de latón

satinado

PROX.
MAY

CLAVE	C/M	MEDIDA
XK-MNS-T01	1/10	17 cm

REGADERA DE FREGADERO

- 2 funciones.
- Con pre-lavado.

rubinett
NUEVO



Acero inoxidable 304

con aireador dorado

PROX.
MAY

CLAVE	C/M	MEDIDA
XK-MND-CT1	1/5	37cm

REGADERA DE FREGADERO

- 2 funciones.
- Con pre-lavado.

rubinett
NUEVO



Acero inoxidable 304

con aireador gun metal

PROX.
MAY

CLAVE	C/M	MEDIDA
XK-MNN-CT1	1/5	37cm

REGADERA DE FREGADERO

- 2 funciones.
- Con pre-lavado.

rubinett
NUEVO



Acero inoxidable 304

con aireador satinado

PROX.
MAY

CLAVE	C/M	MEDIDA
XK-MN-CT1	1/5	37cm



MONOMANDO PARA REGADERA

rubinett
NUEVO



Cuerpo de latón

Cubierta de acero inox.

Maneral metálico

satinado

PROX.
MAY

CLAVE	C/M	DETALLES
XK-MNS-TR1	1/10	S/DESVIADOR

MONOMANDO PARA REGADERA

rubinett
NUEVO



Cuerpo de latón

Cubierta de acero inox.

Maneral metálico

cromado

PROX.
MAY

CLAVE	C/M	DETALLES
XK-MN-TR01	1/10	S/DESVIADOR



MONOMANDO PARA REGADERA

- Con desviador.



● satinado

PROX. MAY

CLAVE	C/M	DETALLES
XK-MNS-TR2	1/10	C/DESVIADOR

MONOMANDO PARA REGADERA

- Con desviador.



● cromado

PROX. MAY

CLAVE	C/M	DETALLES
XK-MN-TR02	1/10	C/DESVIADOR

MONOMANDO PARA REGADERA

- Con desviador.



● mate

PROX. MAY

CLAVE	C/M	DETALLES
XK-MN-RND2	1/10	CUADRADO

MONOMANDO PARA REGADERA

- Con desviador.



● satinado

PROX. MAY

CLAVE	C/M	DETALLES
XK-MN-RSD2	1/10	CUADRADO

MONOMANDO PARA REGADERA

- Con desviador.



● cromado

PROX. MAY

CLAVE	C/M	DETALLES
XK-MN-RCD2	1/10	CUADRADO

MONOMANDO PARA LAVABO



● Cuerpo de latón sólido

● con aireador ● mate

CLAVE	C/M	MEDIDA
XK-MNN-BR2	1/20	18 cm

MONOMANDO PARA LAVABO



● Cuerpo de latón sólido

● con aireador ● mate

CLAVE	C/M	MEDIDA
XK-MNN-BR3	1/20	30cm

TOALLERO DOBLE

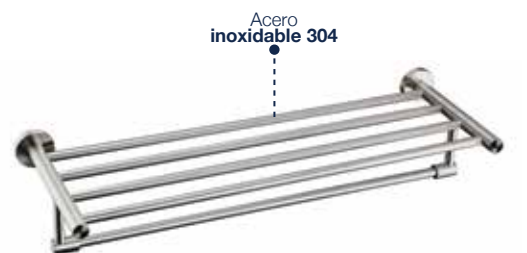

● Acero inoxidable 304

● satinado

PROX. MAY

CLAVE	C/M	MEDIDA
XK-06-DT48	1/20	30cm

TOALLERO DE BARRA



PORTA PAPEL



GANCHO

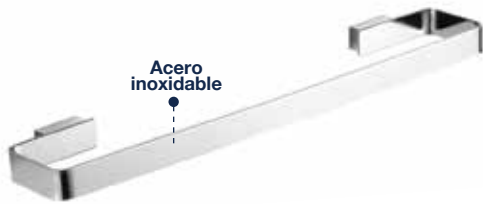

● cromado

PROX. MAY

CLAVE	C/M	MEDIDA
XK-06-BC48	2/10	46cm

● cromado

PROX. MAY

CLAVE	C/M	MATERIAL
XK-06-PC48	2/10	ACERO INOX.

● cromado

PROX. MAY

CLAVE	C/M	MATERIAL
XK-06-GC48	2/10	ACERO INOX.

PORTA VASO

- Incluye vaso.



PORTA JABÓN

- Incluye jabonera.



TOALLERO

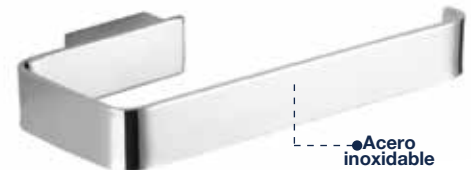

● cromado

PROX. MAY

CLAVE	C/M	MATERIAL
XK-06-VC48	2/10	ACERO INOX.

● cromado

PROX. MAY

CLAVE	C/M	MATERIAL
XK-06-JC48	2/10	ACERO INOX.

● cromado

PROX. MAY

CLAVE	C/M	MATERIAL
XK-06-TC48	2/10	ACERO INOX.

TOALLERO DE BARRA

PORTA PAPEL

GANCHO



● satinado

CLAVE	C/M	MATERIAL
XK-06-BS48	2/10	ACERO INOX.

● satinado

CLAVE	C/M	MATERIAL
XK-06-PS48	2/10	ACERO INOX.

● satinado

CLAVE	C/M	MATERIAL
XK-06-GS48	2/10	ACERO INOX.

PORTA VASO

- Incluye vaso.



● satinado

CLAVE	C/M	MATERIAL
XK-06-VS48	2/10	ACERO INOX.

PORTA JABÓN

- Incluye jabonera.



● satinado

CLAVE	C/M	MATERIAL
XK-06-JS48	2/10	ACERO INOX.

TOALLERO



● satinado

CLAVE	C/M	MATERIAL
XK-06-TS48	2/10	ACERO INOX.

TOALLERO DE BARRA



● mate

CLAVE	C/M	MATERIAL
XK-06-BN48	2/10	ACERO INOX.

PORTA PAPEL



● mate

CLAVE	C/M	MATERIAL
XK-06-PN48	2/10	ACERO INOX.

GANCHO



● mate

CLAVE	C/M	MATERIAL
XK-06-GN48	2/10	ACERO INOX.

PORTA VASO

- Incluye vaso.



● mate

CLAVE	C/M	MATERIAL
XK-06-VN48	2/10	ACERO INOX.

PORTA JABÓN

- Incluye jabonera.



● mate

CLAVE	C/M	MATERIAL
XK-06-JN48	2/10	ACERO INOX.

TOALLERO



● mate

CLAVE	C/M	MATERIAL
XK-06-TN48	2/10	ACERO INOX.

BRAZO

- Para regadera.
- Redondo.
- Satinado.
- **Acero inoxidable 304.**



CLAVE	C/M	MEDIDA
XK-11-303S	10/40	24x340mm

BRAZO

- Para regadera.
- Cuadrado.
- Satinado.
- **Acero inoxidable 304.**



CLAVE	C/M	MEDIDA
XK-11-034S	10/40	320mm

BRAZO

- Para regadera.
- Redondo.
- Negro mate.
- **Acero inoxidable 304.**



CLAVE	C/M	MEDIDA
XK-11-303N	10/40	24x340mm

BRAZO

- Para regadera.
- Cuadrado.
- Negro mate.
- **Acero inoxidable 304.**



CLAVE	C/M	MEDIDA
XK-11-302N	10/40	320mm

REGADERA DE MEDIA PRESIÓN

- No incluye brazo.

Acero inoxidable 304



CLAVE	C/M	MEDIDA
XK-10-311N	1/24	150 mm X 150 mm
XK-10-312N	1/12	200 mm X 200 mm
XK-10-313N	1/6	250 mm X 250 mm

REGADERA DE MEDIA PRESIÓN

- No incluye brazo.

Acero inoxidable 304

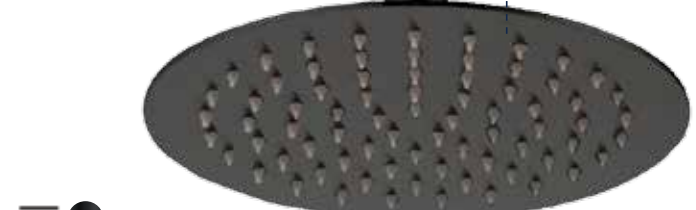

CLAVE	C/M	MEDIDA
XK-10-314N	1/24	ø 150 mm
XK-10-315N	1/12	ø 200 mm
XK-10-316N	1/6	ø 250 mm

REGADERA DE MEDIA PRESIÓN

- No incluye brazo.

Acero inoxidable 304



CLAVE	C/M	MEDIDA
XK-10-311S	1/24	160 mm X 160 mm
XK-10-312S	1/12	220 mm X 220 mm
XK-10-313S	1/6	270 mm X 270 mm

REGADERA DE MEDIA PRESIÓN

- No incluye brazo.

Acero inoxidable 304



CLAVE	C/M	MEDIDA
XK-10-314S	1/24	160 mm X 160 mm
XK-10-315S	1/12	220 mm X 220 mm
XK-10-316S	1/6	270 mm X 270 mm

MONOMANDO PARA FREGADERO



rubinett
NUEVO

PROX.
JUL

CLAVE	C/M	MEDIDA
XK-MN-023	1/20	37cm

MONOMANDO PARA FREGADERO



rubinett
NUEVO

PROX.
JUL

CLAVE	C/M	MEDIDA
XK-MN-024	1/20	33cm

MONOMANDO PARA FREGADERO

- 2 funciones.



CLAVE	C/M	MEDIDA
XK-MNN-CM1	1/20	41cm

MONOMANDO PARA FREGADERO

- Cartucho cerámico.
- 50 cm de altura.
- Disponible en 4 colores.



CLAVE	C/M	COLOR
XK-MN-03A	1/5	AZUL
XK-MN-03B	1/5	BLANCO
XK-MN-03N	1/5	NEGRO
XK-MN-03R	1/5	ROJO

MONOMANDO PARA FREGADERO

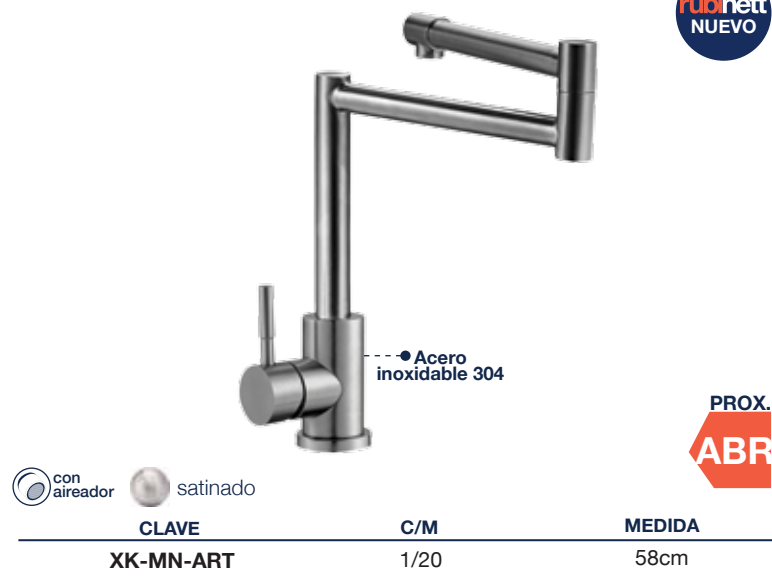

rubinett
NUEVO

PROX.
ABR

CLAVE	C/M	MEDIDA
XK-MN-ART	1/20	58cm

MONOMANDO PARA FREGADERO

- Retráctil.
- 2 funciones.
- Con pre-lavado.
- Para mueble.

producto
MEJORADO



CLAVE	C/M	MEDIDA
XK-MN-020	1/20	58cm

MONOMANDO PARA FREGADERO

- Con pre-lavado.
- Para mueble.
- Chico.

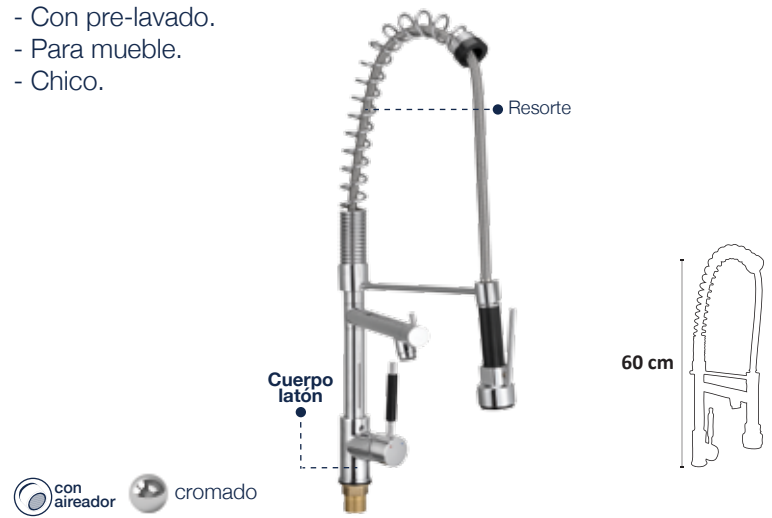

CLAVE	C/M	MEDIDA
XK-MN-018	1/6	60 cm/altura

MONOMANDO PARA FREGADERO

- Con pre-lavado.
- Para mueble.
- Chico.

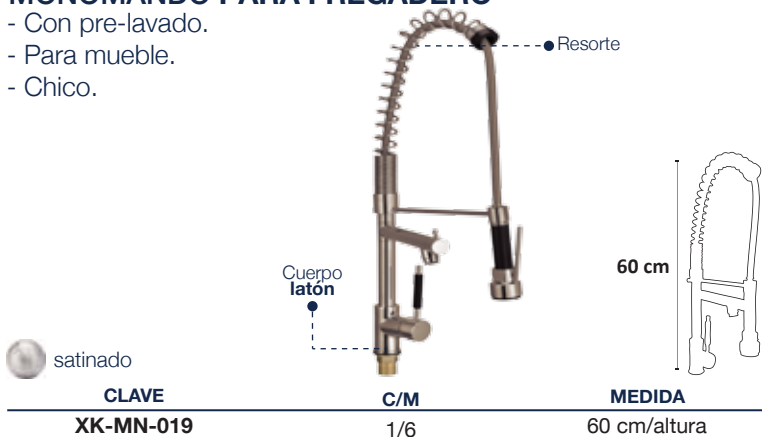

CLAVE	C/M	MEDIDA
XK-MN-019	1/6	60 cm/altura

MONOMANDO PARA FREGADERO

- Con pre-lavado.
- Para mueble.



CLAVE	C/M	MEDIDA
XK-MN-021	1/5	8"

producto MEJORADO

MONOMANDO PARA LAVABO



CLAVE	C/M	MEDIDA
XK-MN-BC1	1/20	17 cm

VÁLVULA ANGULAR

- En latón cromado.
- Cartucho de latón.
- En blister.



CLAVE	C/M	MEDIDA
XP-33-13	1/1	1/2"

VÁLVULA ANGULAR

- En latón cromado.
- Cartucho de latón.
- En blister.



CLAVE	C/M	MEDIDA
XP-43-13	1/1	1/2"

rubinett NUEVO

TARJA DE SUMBONTAR

- Material SS 304.
- Incluye contracanasta.
- Fabricada a mano.
- Calibre 18.
- Espesor 1.1mm



CLAVE	C/M	MEDIDA
XTA-50-45	1/5	50 x 45 x 23 cm

PROX. ABR

TARJA DE SUMBONTAR

- Material SS 304.
- Incluye contracanasta.
- Fabricada a mano.
- Calibre 18.
- Espesor 1.1mm



CLAVE	C/M	MEDIDA
XTA-50-45N	1/5	50 x 45 x 23 cm

PROX. ABR

TARJA DOBLE DE SUMBONTAR

- Material SS 304.
- Incluye 2 contracanastas.
- Fabricada a mano.
- Calibre 18.
- Espesor 1.2mm



CLAVE	C/M	MEDIDA
XTA-78-45	1/5	78 x 45 x 23 cm

PROX. ABR

TARJA DOBLE DE SUMBONTAR

- Material SS 304.
- Incluye 2 contracanastas.
- Fabricada a mano.
- Calibre 18.
- Espesor 1.2mm



CLAVE	C/M	MEDIDA
XTA-78-45N	1/5	78 x 45 x 23 cm

PROX. ABR



alfa[®]

MEZCLADORA PARA LAVABO

- Manerales QUEEN.
- Cuerpo de ABS.

ídrop



CLAVE	C/M	MEDIDA
XDRO-Q10CP	1/20	4"

MEZCLADORA PARA LAVABO

- Manerales en acrílico.
- Cuerpo de ABS.

ídrop



CLAVE	C/M	MEDIDA
X4-A90-FBL	1/20	4"

MEZCLADORA PARA LAVABO

- Manerales ITALIA.
- Cuerpo plástico/aluminio.

ídrop



CLAVE	C/M	MEDIDA
XDROP-4ITA	1/16	4"

MEZCLADORA PARA LAVABO

- Manerales CRUZETA.
- Cuerpo plástico/aluminio.

ídrop



CLAVE	C/M	MEDIDA
XDROP-4CRU	1/20	4"

MEZCLADORA PARA LAVABO

- Manerales QUEEN.
- Cuerpo de latón.

ídrop



CLAVE	C/M	MEDIDA
XDROP-4QU	1/20	4"

MEZCLADORA PARA LAVABO

- Manerales KING.
- Cuerpo de latón.

ídrop



CLAVE	C/M	MEDIDA
XK-09-046A	20/20	4"

MEZCLADORA PARA LAVABO

- Manerales PALANCA.
- Cuerpo de latón.

ídrop



CLAVE	C/M	MEDIDA
XDROP-4ITZ	1/20	4"

LLAVE INDIVIDUAL PARA LAVABO

- Manerales QUEEN.
- Cuerpo de latón.

ídrop



CLAVE	C/M	MEDIDA
XK-10-242	1/40	4"

LLAVE INDIVIDUAL PARA LAVABO

- Manerales Cruzeta.
- Cuerpo de latón.

ídrop



CLAVE	C/M	MEDIDA
XK-10-244	1/40	4"

alfa
NUEVO

MEZCLADORA PARA LAVABO

- Manerales QUEEN.
- Cuerpo de latón.

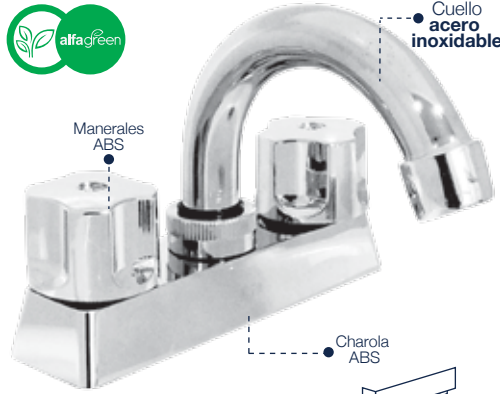

CLAVE	C/M	MEDIDA	
X4-Q10-CD4	1/20	4"	

MEZCLADORA PARA LAVABO

- Manerales QUEEN.
- Cuerpo de latón.



CLAVE	C/M	MEDIDA	
X4-Q10-CD8	1/20	4"	

MEZCLADORA PARA LAVABO

- Manerales ITALIA.
- Cuerpo de latón.

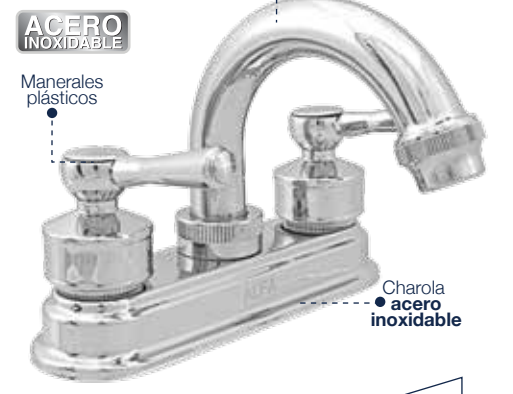

CLAVE	C/M	MEDIDA	
X4-Y10-KB9	1/20	4"	

MEZCLADORA PARA LAVABO

- Manerales QUEEN.
- Cuerpo de latón.

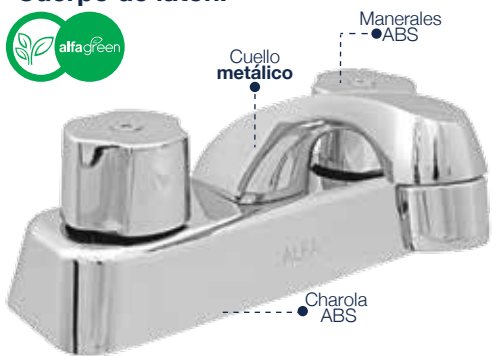

CLAVE	C/M	MEDIDA	
XK-09-046	5/20	4"	

MEZCLADORA PARA LAVABO

- Manerales PIRULI.
- Cuerpo de latón.



CLAVE	C/M	MEDIDA	
X4-P10-CD4	1/20	4"	

MEZCLADORA PARA LAVABO

- Manerales CRUZETA.
- Cuerpo de latón.



CLAVE	C/M	MEDIDA	
X4-Z10-GH4	1/20	4"	

MEZCLADORA PARA LAVABO

- Cuerpo latón.



CLAVE	C/M	MEDIDA	
X4-A90-CD8	1/20	4"	

MEZCLADORA PARA LAVABO

- Manerales KING.
- Cuerpo de latón.

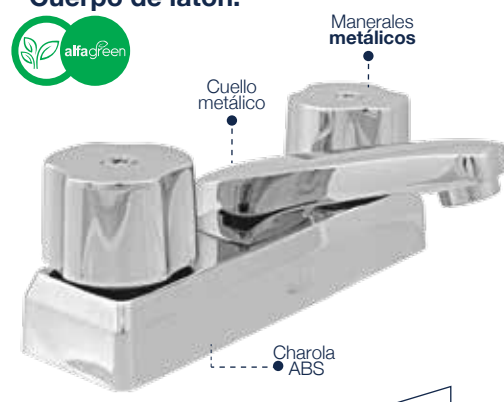

CLAVE	C/M	MEDIDA	
X4-Q10-KGI	1/20	4"	

MEZCLADORA PARA LAVABO

- Manerales OLD ANTIQUE.
- Cuerpo de latón.



CLAVE	C/M	MEDIDA	
X4-N10-KA0	1/20	4"	

MEZCLADORA PARA LAVABO

- Manerales KING.
- Cuerpo de latón.

ACERO INOXIDABLE



Vuelta de 90°
 cromado
 con aireador
 MÁXIMA DURACIÓN

CLAVE	C/M	MEDIDA
X4-K10-046	1/20	4"

MEZCLADORA PARA LAVABO

- Manerales QUEEN.
- Cuerpo de latón.

ACERO INOXIDABLE



Vuelta completa
 cromado
 con aireador
 MÁXIMA DURACIÓN

CLAVE	C/M	MEDIDA
XK-10-047	1/20	4"

MEZCLADORA PARA LAVABO

- Cuerpo latón.

ACERO INOXIDABLE



Vuelta de 90°
 cromado
 con aireador
 MÁXIMA DURACIÓN

CLAVE	C/M	MEDIDA
X4-ANG-KGI	1/20	4"

MEZCLADORA PARA LAVABO

- Cuerpo latón.

ACERO INOXIDABLE



Vuelta de 90°
 cromado
 con aireador
 MÁXIMA DURACIÓN

CLAVE	C/M	MEDIDA
X4-ACU-RES	1/20	4"

alfa NUEVO

PROX. JUL

MEZCLADORA PARA LAVABO

- Cuerpo latón.

ACERO INOXIDABLE



Vuelta de 90°
 cromado
 con aireador
 MÁXIMA DURACIÓN

CLAVE	C/M	MEDIDA
X4-ANG-CD4	1/20	4"

MEZCLADORA PARA LAVABO

- Cuerpo latón.

ACERO INOXIDABLE



Vuelta de 90°
 mate
 con aireador
 MÁXIMA DURACIÓN

CLAVE	C/M	MEDIDA
X4-ACU-NEG	1/20	4"

alfa NUEVO

PROX. ABR

MEZCLADORA PARA LAVABO

- Cuerpo latón.

ACERO INOXIDABLE



Vuelta completa
 mate
 con aireador
 MÁXIMA DURACIÓN

CLAVE	C/M	MEDIDA
X4-Z10-NEG	1/20	4"

alfa NUEVO

PROX. ABR

MEZCLADORA PARA LAVABO

- Cuerpo latón.

ACERO INOXIDABLE



Vuelta completa
 cromado
 con aireador
 MÁXIMA DURACIÓN

CLAVE	C/M	MEDIDA
X4-COB-CD4	1/20	4"

alfa NUEVO

PROX. JUL

MEZCLADORA PARA LAVABO

- Manerales OLD ANTIQUE.
- Cuerpo de latón.

ACERO INOXIDABLE



Vuelta de 90°
 cromado
 con aireador
 MÁXIMA DURACIÓN

CLAVE	C/M	MEDIDA
X4-N10-CD4	1/20	4"

MEZCLADORA PARA LAVABO

- Manerales KING.
- Cuerpo de latón.

ACERO INOXIDABLE



Vuelta de 90°	cromado	con aireador	MÁXIMA DURACIÓN
CLAVE	C/M	MEDIDA	
X4-Q10-KBI	1/20	4"	

alfa NUEVO

MEZCLADORA PARA LAVABO

- Cuerpo latón.

ACERO INOXIDABLE



Vuelta de 90°	cromado	con aireador	MÁXIMA DURACIÓN
CLAVE	C/M	MEDIDA	
X4-CUR-CD8	1/20	4"	

MEZCLADORA PARA LAVABO

- Manerales CRUZETA.
- Cuerpo de latón.

ACERO INOXIDABLE



Vuelta completa	cromado	con aireador	MÁXIMA DURACIÓN
CLAVE	C/M	MEDIDA	
X4-N10-KBI	1/20	4"	

MEZCLADORA PARA LAVABO

- Manerales QUEEN.
- Cuerpo de latón.
- 2 funciones.



Vuelta de 90°	cromado	MÁXIMA DURACIÓN
CLAVE	C/M	MEDIDA
X4-RES-318	1/20	4"

alfa NUEVO

MEZCLADORA PARA LAVABO

- Manerales cruzeta.
- Cuerpo de latón.
- 2 funciones.



Vuelta de 90°	cromado	MÁXIMA DURACIÓN
CLAVE	C/M	MEDIDA
X4-Z10-RES	1/20	4"

alfa NUEVO

MEZCLADORA PARA LAVABO

- Manerales EURO.
- Cuerpo de latón.



Vuelta de 90°	cromado	con aireador	MÁXIMA DURACIÓN
CLAVE	C/M	MEDIDA	
X4-E10-HBI	1/20	4"	

MEZCLADORA PARA LAVABO

- Cuerpo latón.

ACERO INOXIDABLE



Vuelta de 90°	cromado	con aireador	MÁXIMA DURACIÓN
CLAVE	C/M	MEDIDA	
X4-ACU-CD8	1/20	4"	

MEZCLADORA PARA LAVABO

- Manerales PALANCA.
- Cuerpo de latón.

ACERO INOXIDABLE



Vuelta de 90°	cromado	con aireador	MÁXIMA DURACIÓN
CLAVE	C/M	MEDIDA	
X4-I10-CD4	1/20	4"	

MEZCLADORA PARA LAVABO

- Cuerpo latón.

ACERO INOXIDABLE



Vuelta de 90°	cromado	con aireador	MÁXIMA DURACIÓN
CLAVE	C/M	MEDIDA	
X4-ANG-CD8	1/20	4"	

MEZCLADORA PARA LAVABO

- Manerales HARLEY.
- **Cuerpo de latón.**

ACERO INOXIDABLE



Vuelta de 90°	cromado	con aireador	MÁXIMA DURACIÓN
CLAVE	C/M	MEDIDA	
X4-H10-DB	1/20	4"	

MEZCLADORA PARA LAVABO

- Manerales ITALIA.
- **Cuerpo de latón.**

ACERO INOXIDABLE

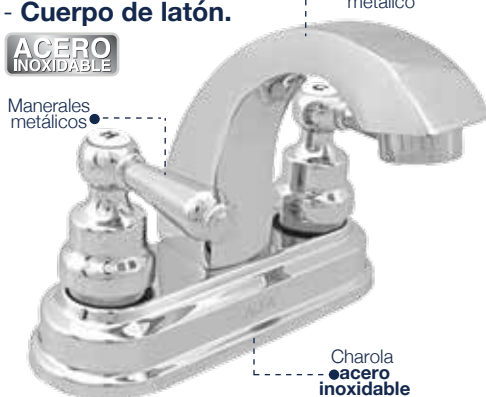

Vuelta de 90°	cromado	con aireador	MÁXIMA DURACIÓN
CLAVE	C/M	MEDIDA	
X4-I10-DB4	1/12	4"	

MEZCLADORA PARA LAVABO

- Manerales ATENAS.
- **Cuerpo de latón.**

ACERO INOXIDABLE



Vuelta de 90°	cromado	con aireador	MÁXIMA DURACIÓN
CLAVE	C/M	MEDIDA	
X4-T20-EC7	1/16	4"	

MEZCLADORA PARA LAVABO

- Manerales OLD ANTIQUE.
- **Cuerpo de latón.**

ACERO INOXIDABLE



Vuelta de 90°	cromado	con aireador	MÁXIMA DURACIÓN
CLAVE	C/M	MEDIDA	
X4-N40-KB8	1/20	4"	

MEZCLADORA PARA LAVABO

- **Cuerpo latón.**

ACERO INOXIDABLE



Vuelta de 90°	satinado	con aireador	MÁXIMA DURACIÓN
CLAVE	C/M	MEDIDA	
X4-ACU-C8S	1/20	4"	

MEZCLADORA PARA LAVABO

- Manerales OLD ANTIQUE.
- **Cuerpo de latón.**

ACERO INOXIDABLE



Vuelta completa	cromado	con aireador	MÁXIMA DURACIÓN
CLAVE	C/M	MEDIDA	
X4-O10-DB4	1/12	4"	

MEZCLADORA PARA LAVABO

- **Cuerpo latón.**

ACERO INOXIDABLE



Vuelta de 90°	cromado	con aireador	MÁXIMA DURACIÓN
CLAVE	C/M	MEDIDA	
X4-ACU-KB8	1/20	4"	

MEZCLADORA PARA LAVABO

- Manerales ATENAS.
- **Cuerpo de latón.**

ACERO INOXIDABLE



Vuelta de 90°	satinado	con aireador	MÁXIMA DURACIÓN
CLAVE	C/M	MEDIDA	
X4-T30-EC7	1/16	4"	

MEZCLADORA PARA LAVABO

- **Cuerpo de latón.**

ACERO INOXIDABLE



Vuelta completa	cromado	MÁXIMA DURACIÓN
CLAVE	C/M	MEDIDA
X4-CUA-CR	1/10	4"

MEZCLADORA PARA LAVABO

- Cuerpo de latón.

ACERO INOXIDABLE



CLAVE	C/M	MEDIDA
X4-GAR-CR	1/10	4"

MEZCLADORA PARA LAVABO

- Cuerpo de latón.

ACERO INOXIDABLE

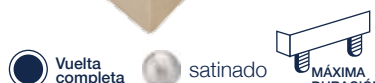

CLAVE	C/M	MEDIDA
X4-CUA-SA	1/10	4"

MEZCLADORA PARA LAVABO

- Cuerpo de latón.

ACERO INOXIDABLE

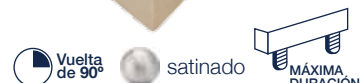

CLAVE	C/M	MEDIDA
X4-GAR-SA	1/10	4"

MEZCLADORA PARA LAVABO

- Manerales MADDALENA.

- Cuerpo de latón.



CLAVE	C/M	MEDIDA
X9-Z10-LDB	1/10	8"

MONOMANDO PARA LAVABO

- Cuerpo de latón.

alfa
NUEVO



CLAVE	C/M	MEDIDA
XK-MN-L01	1/12	4"

MONOMANDO PARA LAVABO

MODELO: SIRIO

- Cuerpo de latón.

ACERO INOXIDABLE



CLAVE	C/M	MEDIDA
XK-MN-001	1/12	30 cm

MONOMANDO PARA LAVABO

MODELO: MAYA

- Cuerpo de latón.



CLAVE	C/M	MEDIDA
XK-MN-004	1/12	35 cm

MONOMANDO PARA LAVABO

MODELO: REALE

- Cuerpo de latón.

ACERO INOXIDABLE



CLAVE	C/M	MEDIDA
XK-MN-006	1/12	21 cm

MONOMANDO PARA LAVABO

MODELO: PAMY

- Cuerpo de acero inoxidable.

ACERO INOXIDABLE



CLAVE	C/M	MEDIDA
XK-MN-003	1/12	17 cm

MONOMANDO PARA LAVABO

MODELO: VENUS

- Cuerpo de latón.



CLAVE	C/M	MEDIDA
XK-MN-002	1/12	31.5 cm

MONOMANDO PARA LAVABO

MODELO: UNIKA

- Cuerpo de latón.



CLAVE	C/M	MEDIDA
XK-MN-005	1/20	17 cm

MONOMANDO PARA LAVABO

ACERO INOXIDABLE

alfa NUEVO



CLAVE	C/M	MEDIDA
XK-MN-07S	1/12	17 cm

PROX. MAY

MONOMANDO PARA LAVABO

ACERO INOXIDABLE

alfa NUEVO



CLAVE	C/M	MEDIDA
XK-MNN-005	1/20	17 cm

PROX. ABR

MONOMANDO PARA LAVABO

- Cuerpo de latón.

alfa NUEVO



CLAVE	C/M	MEDIDA
XK-MN-06C	1/12	17 cm

PROX. ABR

TEMPORIZADOR PARA LAVABO

- Cuerpo de latón.



CLAVE	C/M	MEDIDA
XK-MN-A01	1/50	20 cm

alfaGreen

BARRA DE SEGURIDAD

alfa NUEVO



CLAVE	C/M	ACABADO	MEDIDA
XK-BR-01	1/50	CROMADO	61 cm
XK-BR-01S	1/50	SATINADO	61 cm

PROX. MAY

BARRA DE SEGURIDAD

alfa NUEVO

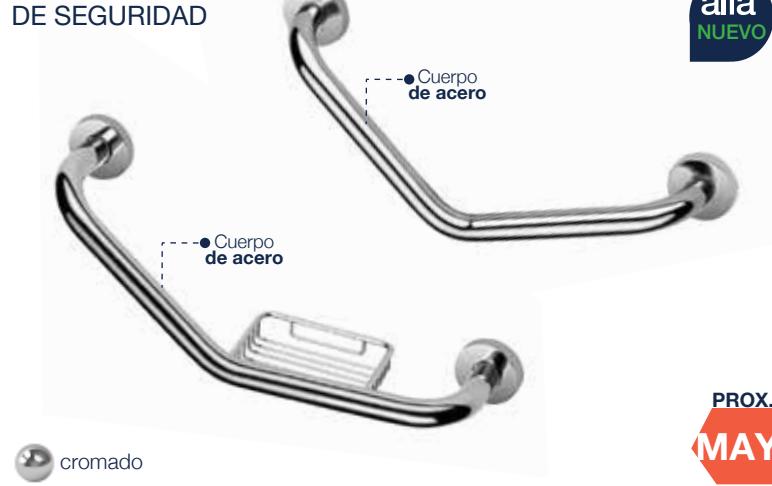

CLAVE	C/M	DETALLES	MEDIDA
XK-BR-02	1/50	S/JABONERA	39 cm
XK-BR-02J	1/50	C/JABONERA	42 cm

PROX. MAY



JUEGOS DE BAÑO

JUEGO DE BAÑO DE 5 PIEZAS.

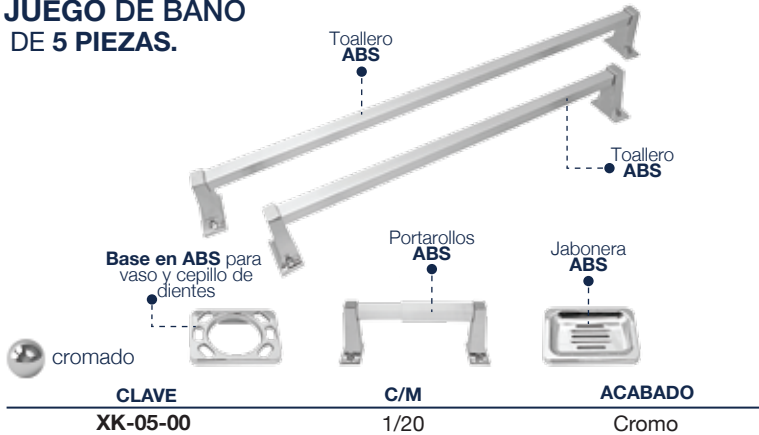

JUEGO DE BAÑO DE 6 PIEZAS.

- Modelo: Italia.

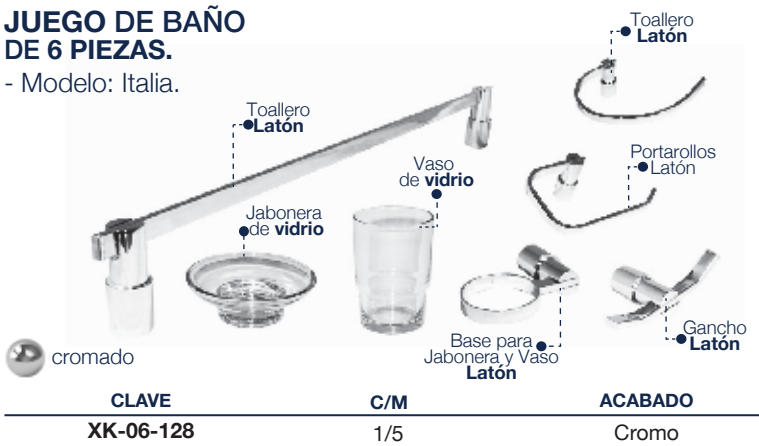

JUEGO DE BAÑO DE 6 PIEZAS.

- Modelo: Old Antique.

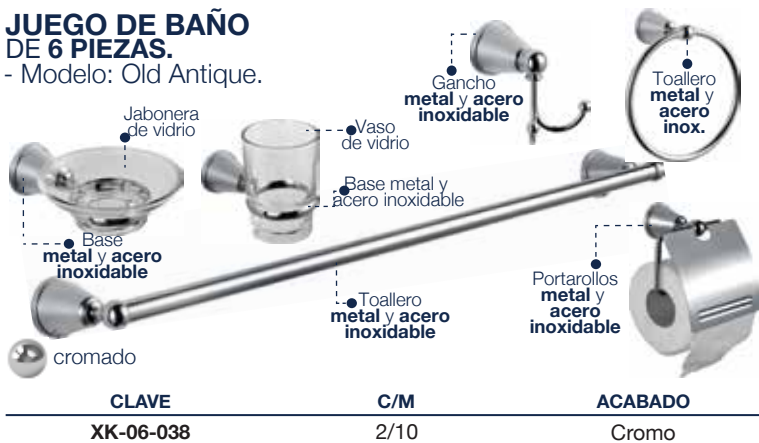

JUEGO DE BAÑO DE 5 PIEZAS.

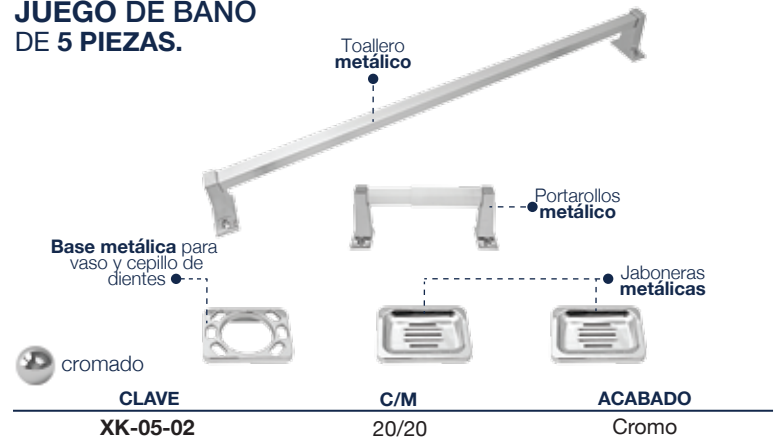

JUEGO DE BAÑO DE 6 PIEZAS.

- Modelo: Sunlight



JUEGO DE BAÑO DE 6 PIEZAS.

- Modelo: Mónaco.

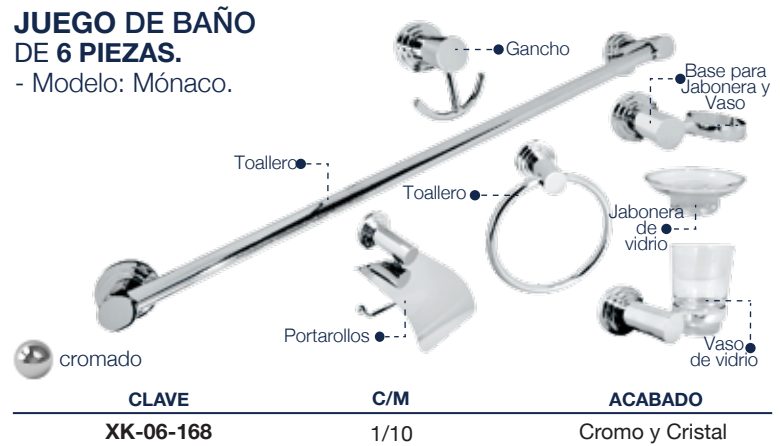

JUEGO DE BAÑO DE 6 PIEZAS.

- Modelo: Sunset.

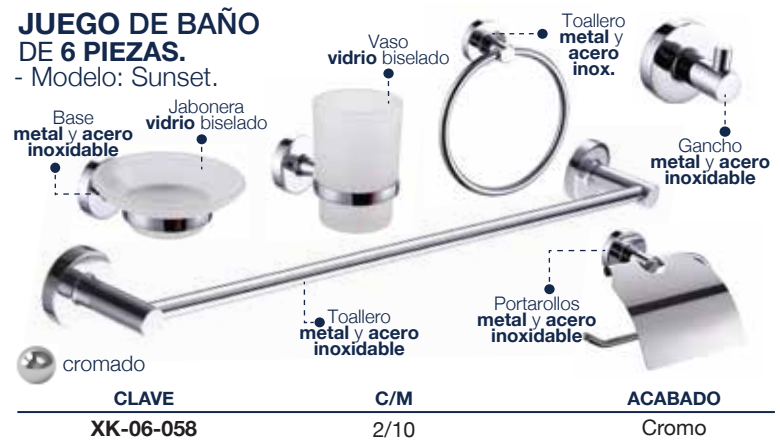

JUEGO DE BAÑO DE 6 PIEZAS.



cromado

CLAVE

C/M

ACABADO

XK-06-078

1/5

Cromo

JUEGO DE BAÑO DE 6 PIEZAS.



cromado

CLAVE

C/M

ACABADO

XK-06-088

1/5

Cromo

JUEGO DE BAÑO DE 6 PIEZAS.



cromado

CLAVE

C/M

ACABADO

XK-06-048

1/5

Cromo

JUEGO DE BAÑO DE 6 PIEZAS.



cromado

CLAVE

C/M

ACABADO

XK-06-148

1/5

Cromo

JABONERA



cromado

CLAVE

C/M

XK-JR-129

1/20

JABONERA
- Tipo rejilla.
- Linea: ITALIA.

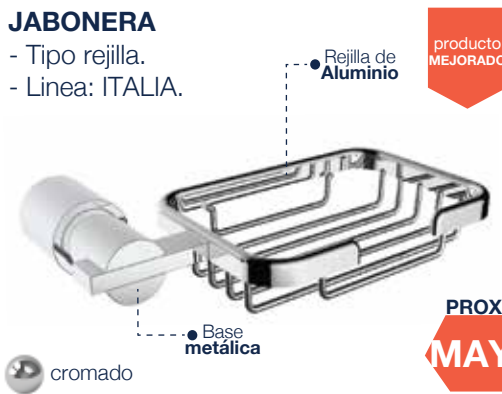

cromado

CLAVE

C/M

XK-JR-128

1/20

PORTA ROLLOS



cromado

CLAVE

C/M

XK-PP-129

1/20

TOALLERO DOBLE

- De latón.
- Linea: ITALIA.



cromado

CLAVE

C/M

XK-DT-128

1/10

DESPACHADOR DE JABÓN

- De cristal satinado.
- Linea: ITALIA.



cromado

CLAVE

C/M

XK-DJ-128

1/20



REGADERAS



REGADERA DE BAJA PRESIÓN.
- 4 a 8 litros por minuto.



NOM

CLAVE

XK-10-301

C/M

1/50

MEDIDA

70 mm



REGADERA DE BAJA PRESIÓN.
- 4 a 8 litros por minuto.



NOM

CLAVE

XK-10-303

C/M

1/50

MEDIDA

70 mm

REGADERA DE BAJA PRESIÓN.
- 4 a 8 litros por minuto.



NOM

CLAVE

XK-10-302

C/M

1/50

MEDIDA

50 mm

REGADERA DE BAJA PRESIÓN.
- 4 a 8 litros por minuto.



CLAVE

XK-10-303M

C/M

1/50

MEDIDA

70 mm

REGADERA DE BAJA PRESIÓN.
- 4 a 8 litros por minuto.
- **No incluye** brazo ni chapetón.



NOM - CNCP

CLAVE

XK-10-305

C/M

1/50

MEDIDA

50 mm

REGADERA DE BAJA PRESIÓN.
- 3.8 litros por minuto.



CLAVE

XK-10-306

C/M

1/50

MEDIDA

10 mm

REGADERA DE BAJA PRESIÓN.
- Antisarro.
- 4 a 8 litros por minuto.
- **No incluye** brazo ni chapetón.



NOM - CNCP

CLAVE

XK-20-FA

C/M

1/50

MEDIDA

80 mm



REGADERA DE BAJA PRESIÓN.

- Incluye obturador.
- **No incluye** brazo ni chapetón.
- 4 a 8 litros por minuto.



CLAVE	C/M	MEDIDA
XK-21-FA	1/40	80 mm

REGADERA DE BAJA PRESIÓN.

- 4 a 8 litros por minuto.
- Cuadrada.
- **Satinada.**



CLAVE	MEDIDA
XK-10-307S	200 x 200 mm

REGADERA DE BAJA PRESIÓN.

- 4 a 8 litros por minuto.



CLAVE	C/M
XK-10-309	1/50

REGADERA DE BAJA PRESIÓN.

- 4 a 8 litros por minuto.



CLAVE	C/M
XK-10-310	1/50

REGADERA DE PRESIÓN MEDIA.

- **No incluye** brazo.



CLAVE	C/M	MEDIDA
XK-10-311	1/24	150 mm x 150 mm
XK-10-312	1/12	200 mm x 200 mm
XK-10-313	1/6	250 mm x 250 mm

REGADERA DE PRESIÓN MEDIA.

- **No incluye** brazo.

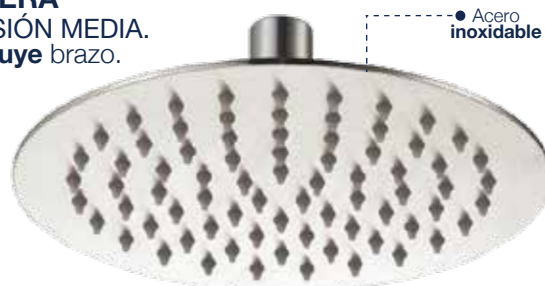

CLAVE	C/M	MEDIDA
XK-10-314	1/24	∅ 150 mm
XK-10-315	1/12	∅ 200 mm
XK-10-316	1/6	∅ 250 mm

BRAZO PARA REGADERA

- Cuadrado.



CLAVE	C/M	ACABADO	MEDIDA
XK-11-302	10/40	CROMO	320mm
XK-11-302N	10/40	NEGRO MATE	320mm

BRAZO PARA REGADERA

- Redondo.



CLAVE	C/M	ACABADO	MEDIDA
XK-11-303	10/40	CROMO	340mm
XK-11-303N	10/40	NEGRO MATE	340mm

REGADERA DE TELÉFONO

- Con **tuerca de latón.**
- Incluye bracket.
- 5 funciones.

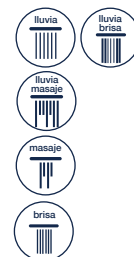

CLAVE	C/M
XK-10-317T	1/1

OBTURADOR PARA REGADERA

- En ABS cromado.
- Para detener el flujo de agua.



DESVIADOR CON O' RING Y FILTRO

- En ABS.
- Tapón de POM.



SOPORTE PARA REGADERA

- En ABS.



CLAVE	C/M	MEDIDA
XK-20-STOP	1/1000	STD

CLAVE	C/M	MEDIDA
XK-20-DES	1/1000	STD

CLAVE	C/M	MEDIDA
XK-20-SOP	1/1000	STD

MANERAL ACRÍLICO PARA MEZCLADORA.

- Juego de 2 piezas.
- Sin chapetón.



CLAVE	C/M	COLOR
X1-AH00-MZ	1/100	Humo

MANERAL ACRÍLICO PARA MEZCLADORA.

- Juego de 2 piezas.
- Sin chapetón.



CLAVE	C/M	COLOR
X1-A00-MZ	1/100	Transparente

MANERAL ACRÍLICO PARA MEZCLADORA.

- Juego de 2 piezas.
- Sin chapetón.



CLAVE	C/M	COLOR
X1-AM00-MZ	1/100	Ambar

MANERAL ACRÍLICO PARA MEZCLADORA.

- Juego de 2 piezas.
- Sin chapetón.



CLAVE	C/M	COLOR
X1-AZ00-MZ	1/100	Azul

MANERAL QUEEN CHICO PARA MEZCLADORA.

- Juego de 2 piezas.
- Sin chapetón.



CLAVE	C/M	COLOR
XK-20-03	1/100	Cromo

MANERAL ACRÍLICO PARA REGADERA.

- Con chapetón.
- Juego de 2 piezas.
- Sin válvula de empotrar.



CLAVE	C/M	COLOR
X1-AH00	1/50	Humo

MANERAL ACRÍLICO PARA REGADERA.

- Con chapetón.
- Juego de 2 piezas.
- Sin válvula de empotrar.



CLAVE	C/M	COLOR
X1-AZ00	1/50	Azul

MANERAL ACRÍLICO PARA REGADERA.

- Con chapetón.
- Juego de 2 piezas.
- Sin válvula de empotrar.



CLAVE	C/M	COLOR
X1-A00	1/50	Transparente

MANERAL ACRÍLICO PARA REGADERA.

- Con chapetón.
- Juego de 2 piezas.
- Sin válvula de empotrar.



CLAVE	C/M	COLOR
X1-AM00	1/50	Ambar

producto MEJORADO

MANERAL PIRULÍ PARA REGADERA.

- Juego de 2 piezas.
- Sin válvula de empotrar.



CLAVE	C/M	COLOR
X1-P60	1/50	Blanco

MANERAL QUEEN GRANDE PARA REGADERA.

- Juego de 2 piezas.
- Sin válvula de empotrar.



CLAVE	C/M	COLOR
XK-20-05	1/100	Cromo

MANERAL OLD ANTIQUE PARA REGADERA.

- Juego de 2 piezas.
- Sin válvula de empotrar.



CLAVE	C/M	COLOR
X1-000	2/80	Cromo

SALIDA PARA TINA SIN DESVIADOR.

- Cuerpo metálico.
- Sin válvula.
- 178g.



CLAVE	C/M	COLOR
XK-TIN-DES	1/50	Cromo

SALIDA PARA TINA CON DESVIADOR.

- Cuerpo metálico.
- 236.5g.



CLAVE	C/M	COLOR
XK-TIN-DES	1/100	Cromo

JUEGO DE LLAVES DE EMPOTRAR C/ MANERAL ACRÍLICO.

- Juego de 2 piezas.



CLAVE	C/M	MEDIDA
XK-13-A90	2/32	1/2"

JUEGO DE LLAVES DE EMPOTRAR MANERAL QUEEN GDE.

- Cartucho cerámico.
- Juego de 2 piezas.



CLAVE	C/M	MEDIDA
XK-11-052	1/32	1/2"

JUEGO DE LLAVES DE EMPOTRAR C/ MANERAL QUEEN GDE.

- Cartucho cerámico.
- Juego de 2 piezas.



CLAVE	C/M	MEDIDA
XK-11-652	1/32	1/2"

JUEGO DE LLAVES DE EMPOTRAR C/ MANERAL QUEEN GDE.

- Válvula de latón.
- Juego de 2 piezas.



CLAVE	C/M	MEDIDA
XK-13-052	1/32	1/2"

JUEGO DE LLAVES DE EMPOTRAR C/ MANERAL QUEEN GDE.

- Cartucho cerámico.
- Juego de 2 piezas.



CLAVE	C/M	MEDIDA
XK-13-652	1/32	1/2"

LLAVES DE EMPOTRAR

- De latón.
- Juego de 2 piezas.



CLAVE	C/M	MEDIDA
XK-12-052	1/32	1/2"

LLAVES DE EMPOTRAR

- De latón.
- Juego de 2 piezas.



CLAVE	C/M	MEDIDA
XK-12-652	1/50	1/2"

LLAVES DE EMPOTRAR

- De latón.
- Para CPVC.
- Juego de 2 piezas.



● Cartucho de compresión

● Roscable

● Vuelta completa

CLAVE	C/M	MEDIDA
XK-10-752	1/40	1/2"

LLAVES DE EMPOTRAR

- De latón.
- Juego de 2 piezas.



● Cartucho cerámico

● Roscable

● Vuelta de 90°

CLAVE	C/M	MEDIDA
XK-10-052	1/50	1/2"

LLAVES DE EMPOTRAR

- De latón.
- Juego de 2 piezas.



● Cartucho cerámico

● Soldable

● Vuelta de 90°

CLAVE	C/M	MEDIDA
XK-10-652	1/50	1/2"

LLAVE DE EMPOTRAR

- De CPVC.
- Juego de 2 piezas.
- De cementar.



● Vuelta de 90°

CLAVE	C/M	MEDIDA
XK-10-852	1/72	1/2"

KIT PARA REGADERA DE CPVC



● Codo oreja 90° x 1/2"

● Yee 1/2"

● Codos 90° x 1/2"

● Manerales con chapetón

● Llaves de empotrar

CLAVE	C/M	MEDIDA
Z-KITCPVC	1/16	1/2"

KIT PARA REGADERA DE PPR

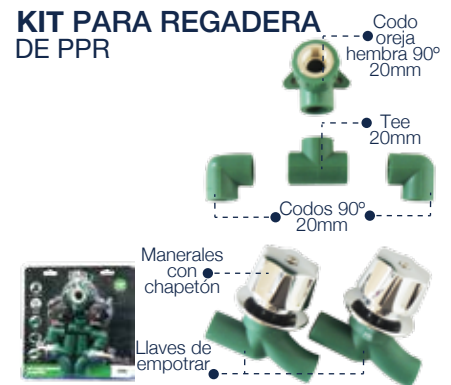

● Codo oreja hembra 90° 20mm

● Tee 20mm

● Codos 90° 20mm

● Manerales con chapetón

● Llaves de empotrar

CLAVE	C/M	MEDIDA
Z-KITPPR	1/16	20mm



Y CONTRAS

CESPOL RÍGIDO PARA LAVABO

- De PP.
- Con cubierta.



● Cubierta de acero inoxidable

● Desagüe

● Salida rígida

● Registro

CLAVE	C/M	MEDIDA
XK-10-203	GRANEL	STD

CESPOL PARA LAVABO

- De PVC.



● Cubierta y moneda de acero inoxidable

● Desagüe

● Salida flexible

● Registro

CLAVE	C/M	DETALLES
XK10202B	GRANEL	S/CUBIERTA
XK10202BC	GRANEL	C/CUBIERTA
XK10202BM	GRANEL	C/CUBIERTA Y MONEDA

CESPOL PARA LAVABO

- De PP.



● Cubierta y moneda de acero inoxidable

● Desagüe

● Salida rígida

● Bote chico

CLAVE	C/M	DETALLES
XK10200	GRANEL	S/CUBIERTA
XK10200CBC	GRANEL	C/CUBIERTA
XK10200CBM	GRANEL	C/CUBIERTA Y MONEDA

CESPOL PARA LAVABO

- De PP.



● Cubierta y moneda de acero inoxidable

● Desagüe

● Salida flexible

● Bote chico

CLAVE	C/M	DETALLES
XK10218CB	GRANEL	S/CUBIERTA
XK10218CBC	GRANEL	C/CUBIERTA
XK10218CBM	GRANEL	C/CUBIERTA Y MONEDA

CESPOL PARA LAVABO

- De PP.

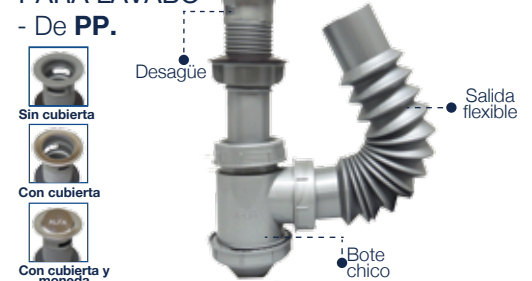

● Cubierta y moneda de acero inoxidable

● Desagüe

● Salida flexible

● Bote chico

CLAVE	C/M	DETALLES
XK10218CG	GRANEL	S/CUBIERTA
XK10218CGC	GRANEL	C/CUBIERTA
XK10218CGM	GRANEL	C/CUBIERTA Y MONEDA

CESPOL PARA LAVABO - De PP.



CLAVE	C/M	DETALLES
XK10226GB	GRANEL	S/CUBIERTA
XK10226GBC	GRANEL	C/CUBIERTA
XK10226GBM	GRANEL	C/CUBIERTA Y MONEDA

CESPOL PARA LAVABO - De PP.



CLAVE	C/M	DETALLES
XK10226GG	GRANEL	S/CUBIERTA
XK10226GGC	GRANEL	C/CUBIERTA
XK10226GGM	GRANEL	C/CUBIERTA Y MONEDA

CESPOL PARA LAVABO - De PP.



CLAVE	C/M	DETALLES
XK10235B	GRANEL	S/CUBIERTA
XK10235BC	GRANEL	C/CUBIERTA
XK10235BM	GRANEL	C/CUBIERTA Y MONEDA

CESPOL PARA LAVABO - De PP.



CLAVE	C/M	DETALLES
XK10235G	GRANEL	S/CUBIERTA
XK10235GC	GRANEL	C/CUBIERTA
XK10235GM	GRANEL	C/CUBIERTA Y MONEDA

CESPOL CUADRADO PARA LAVABO - De PP.



CLAVE	C/M	DETALLES
XK-10-100	GRANEL	C/CUBIERTA Y MONEDA

CESPOL CUADRADO PARA LAVABO



CLAVE	C/M	DETALLES
XK-10-101	GRANEL	C/CUBIERTA Y MONEDA

CESPOL PARA LAVABO



CLAVE	C/M	DETALLES
XK-10-207	20/20	C/MONEDA

CESPOL PARA LAVABO



CLAVE	C/M	DETALLES
XK-10-208	1/50	C/MONEDA

CESPOL PARA LAVABO



CLAVE	C/M	DETALLES
XK-10-207A	1/20	C/MONEDA

CESPOL PARA LAVABO



CLAVE	C/M	DETALLES
XK-10-209	1/20	SIST. POP UP

CESPOL PARA LAVABO - Sin desagüe.



CLAVE	C/M	DETALLES
XK-10-209A	1/20	SIST. POP UP

CESPOL PARA LAVABO



CLAVE	C/M
XK-10-219	1/20

CESPOL PARA LAVABO



Acero inoxidable

● cromado

CLAVE

C/M

XK-10-220

1/20



TRAMPA UNIVERSAL P/LAVABO O FREGADERO

- De PP.



Flexible

CLAVE

C/M

MEDIDA

XK-13-265

GRANEL

STD

TRAMPA UNIVERSAL P/LAVABO O FREGADERO

- De PVC.

- Sin registro.



Rígido

CLAVE

C/M

MEDIDA

XK-13-370

GRANEL

STD

TRAMPA UNIVERSAL P/LAVABO O FREGADERO

- De PVC.



Rígido

● Registro

CLAVE

C/M

MEDIDA

XK-13-370C

GRANEL

STD

TRAMPA UNIVERSAL P/LAVABO O FREGADERO

- De PVC.

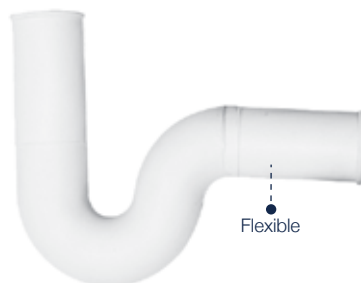

Flexible

CLAVE

C/M

MEDIDA

XK13808

GRANEL

STD

TRAMPA PARA LAVABO



Acero inoxidable

● cromado

CLAVE

C/M

MEDIDA

XK-10-207C

10/50

STD

CONTRA PARA LAVABO

- De PP.



Sin cubierta

Con cubierta

Con cubierta y moneda



● Cubierta y moneda de acero inoxidable

Desagüe

CLAVE

C/M

DETALLES

XK14221B

GRANEL

S/CUBIERTA

XK14221BC

GRANEL

C/CUBIERTA

XK14221BM

GRANEL

C/CUBIERTA Y MONEDA

CONTRA PARA LAVABO

- De PP.

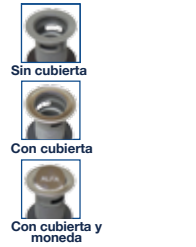

Sin cubierta

Con cubierta

Con cubierta y moneda



● Cubierta y moneda de acero inoxidable

Desagüe

CLAVE

C/M

DETALLES

XK14221G

GRANEL

S/CUBIERTA

XK14221GC

GRANEL

C/CUBIERTA

XK14221GM

GRANEL

C/CUBIERTA Y MONEDA

CONTRA PARA LAVABO



● Moneda de acero inoxidable

● Desagüe

● Metal

● cromado

CLAVE

C/M

DETALLES

XK-10-207M

1/50

C/MONEDA

CONTRA PARA LAVABO



● Desagüe

● Latón



Pop up redondo

● cromado

CLAVE

C/M

DETALLES

XK-15-00

1/50

SIST. POP UP

CONTRA PARA LAVABO



● Sistema Pop up cuadrado

● Desagüe

● Latón

● cromado

CLAVE

C/M

DETALLES

XK-16-00

1/50

SIST. POP UP

POP UP PARA LAVABO



● Sistema Pop up cuadrado

● Latón

● mate

CLAVE

C/M

DETALLES

XK-15-00N

1/50

SIST. POP UP



PROX. JUL

POP UP PARA LAVABO



Sistema Pop up cuadrado

rubinett
NUEVO

Latón

● mate

CLAVE	C/M	DETALLES
XK-16-00N	1/50	SIST. POP UP

CASQUILLOS PARA CONTRA DE LAVABO

Aluminio



CLAVE	C/M	MEDIDA
XCL-10-10	GRANEL	10 cm
XCL-10-15	GRANEL	15 cm
XCL-10-20	GRANEL	20 cm

TAPÓN PARA LAVABO



CLAVE	C/M	MEDIDA
XK-17-25	1/50	1"
XK-17-32	1/50	1-1/4"



MUEBLES PARA BAÑO

MUEBLE PARA BAÑO

- Básico.
- Color: Wengué.
- Mueble con lavamanos.
- 1 puerta.



CLAVE	C/M	MEDIDA
XT-124	1/1	50 x 47.5 x 38 cm

MUEBLE PARA BAÑO

- Modelo: Valdez
- Color: Pino.
- Mueble con lavamanos.
- Con cajones.



CLAVE	C/M	MEDIDA
XT-240	1/1	89 x 47.5 x 43 cm

MUEBLE PARA BAÑO

- Modelo: Misus.
- Color: Wengué.
- Mueble con lavamanos.
- Set de 2 piezas.
- Medidas del espejo: 50 cm X 64 cm.



CLAVE	C/M	MEDIDA
XT-220	1/1	53 x 63 x 48 cm

MUEBLE PARA BAÑO

- Modelo: Vivaldi.
- Color: Wengué.
- Mueble con lavamanos.
- Set de 3 piezas.
- Medidas del espejo: 50 cm X 74 cm
- Medidas de alacena: 60 cm X 30 cm X 30 cm



CLAVE	C/M	MEDIDA
XT-320	1/1	53 x 78.5 x 48 cm

W.C. CERÁMICO

- De 1 sola pieza.
- Tapa de cierre lento.
- Descargas de 4.8 Litros.
- Incluye: Aro de cera y manguera flexible.

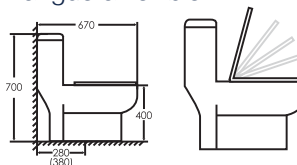

CLAVE	C/M	MEDIDA
XWCBCI-001	1/1	67 x 70 40 cm

OVALIN CERÁMICO

- Redondo.
- Color blanco opaco.
- No incluye accesorios.



CLAVE	C/M	MEDIDA
XK-CER-45	1/1	46x46x15.5 cm

OVALIN CERÁMICO

- Rectángular.
- Color blanco opaco.
- No incluye accesorios.



CLAVE	C/M	MEDIDA
XK-CER-46	1/1	40 x 30 x 12cm

W.C. CERÁMICO

- De 2 piezas.
- **Incluye:**
Herraje
Tapa Asiento
Botón Lateral



CLAVE	C/M	MEDIDA
WC-ECO-2PC	1/1	69 X 36 X 77cm

TAPA ASIENTO BLANCO.

- Caída lenta.



CLAVE	C/M	DETALLES
XTP-WC-BCL	1/10	CORTO
XTP-WC-BLL	1/10	LARGO

ASIENTO CORTO CON TAPA.

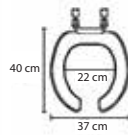

CLAVE	COLOR
090015	BLANCO
090019	BEIGE

TORNILLO

- Con mariposa.
- Para tanque de taza de W.C.



CLAVE	C/M	MEDIDA
N-04-18	GRANEL	STD

PERA

- Para W.C.



CLAVE	COLOR	MEDIDA
XPP-06-06	NEGRO	STD

SAPO NEGRO

- PARA W.C.
- De PVC.



CLAVE	C/M	MEDIDA
XS-06-13	5/5	STD

SAPO AZUL

- PARA W.C.
- De Plástico.
- Con blister.



CLAVE	C/M	MEDIDA
XS-07-13	40/80	STD

CUELLO DE CERA

- PARA W.C.
- Sin guía.



CLAVE	C/M	MEDIDA
XJP-00-00	16/16	STD

CUELLO DE CERA

- PARA W.C.
- Con guía.



CLAVE	C/M	MEDIDA
XJP-00-01	10/10	STD

BRIDA

- PARA W.C.
- De PVC.
- No incluye tornillos.



CLAVE	C/M	MEDIDA
XBP-00-13	GRANEL	STD

JUEGO DE HERRAJES PARA W.C.

- De Plástico.



CLAVE	C/M	MEDIDA
Z-87-01	1/50	STD

BOTÓN DE REFACCIÓN PARA W.C.

- Para sistemas dual flush.
- Botón de **descarga doble**.



CLAVE	C/M	DETALLES
XN-10-RED	10/400	REDONDO

BOTÓN DE REFACCIÓN PARA W.C.

- Para sistemas dual flush.
- W.C. con botón en tapa.
- Botón de **descarga doble**.
- Negro.



CLAVE	C/M	DETALLES
XN-10-REDN	1/1	REDONDO

BOTÓN UNIVERSAL PARA W.C.

- Para sistemas dual flush.
- W.C. con botón en tapa.
- Adaptable a las medidas del botón.



DIÁMETROS
40 mm
50 mm
60 mm

CLAVE	C/M	DETALLES
XN-10-UNIV	1/1	REDONDO

BOTÓN DE REFACCIÓN PARA W.C.

- Para sistemas dual flush.
- Botón de descarga doble.



CLAVE	C/M	DETALLES
XN-10-CUA	10/400	CUADRADO

MANIVELA PARA W.C.

- Con varilla tropicalizada.
- Varilla de metal.
- En ABS.



CLAVE	C/M	MEDIDA
XSN-17-13	50/200	1/2"

FLOTADOR PARA W.C.

- De plástico.
- Para tanque bajo.
- Con varilla.



CLAVE	C/M	MEDIDA
XPN-04-13	1/1	No.4

VÁLVULA DE DESCARGA DUAL FLUSH SISTEMA AHORRADOR DE AGUA

- Descarga de 3 y 6 litros.
- Sin válvula de admisión.
- Con botón a un lado.



CLAVE	C/M	MEDIDA
XN-09-1306	1/28	STD

VÁLVULA DE ADMISIÓN PARA W.C.

- De plástico.



CLAVE	C/M	MEDIDA
XN-08-13	1/1	STD

VÁLVULA DE DESCARGA PARA W.C.

- De plástico.
- Con sapo.



CLAVE	C/M	MEDIDA
XPN-06-13	1/1	STD

VÁLVULA DE TANQUE BAJO PARA DUAL FLUSH O WC TRADICIONAL

- Fácil instalación.



CLAVE	C/M	MEDIDA
XN-05-1314	1/1	STD

VÁLVULA DE DESCARGA DUAL FLUSH SISTEMA AHORRADOR DE AGUA

- Descarga de 3 y 6 litros.
- Sin válvula de admisión.
- Para W.C. con botón en tapa.



CLAVE	C/M	MEDIDA
XN-10-1306	1/1	STD

VÁLVULA DUAL FLUSH SISTEMA AHORRADOR DE AGUA

- Descarga de 3 y 6 litros.
- Para W.C. tradicional.



CLAVE	C/M	MEDIDA
XN-09-13	1/24	STD

VÁLVULA DUAL FLUSH SISTEMA AHORRADOR DE AGUA

- Descarga de 3 y 6 litros.
- Para W.C. con botón en tapa.



CLAVE	C/M	EMPAQUE
XN-10-13B	1/20	BOLSA
XN-10-13	1/24	CAJA

VÁLVULA DE DESCARGA PARA INSTALAR EN CONTRA DE LATÓN

- Incluye: Soporte universal.
- Válvula de admisión y flotador.
- No incluye contra.



CLAVE	C/M	MEDIDA
XN-09-1308	1/1	UNIVERSAL

VÁLVULA DUAL FLUSH SISTEMA DE REPARACIÓN

- Para instalar en contra de PVC.
- Incluye: Válvula de admisión y flotador.
- No incluye contra de tanque bajo.



CLAVE	C/M	MEDIDA
XN-09-1309	1/1	UNIVERSAL

VÁLVULA ANGULAR



CLAVE	C/M	MEDIDA
XP-50-13N	1/50	1/2"

VÁLVULA ANGULAR

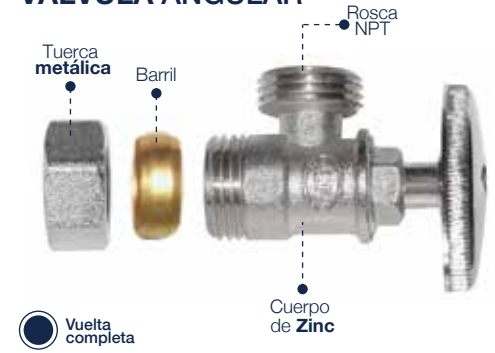

CLAVE	C/M	MEDIDA
P-30-13	20/200	1/2"

VÁLVULA ANGULAR

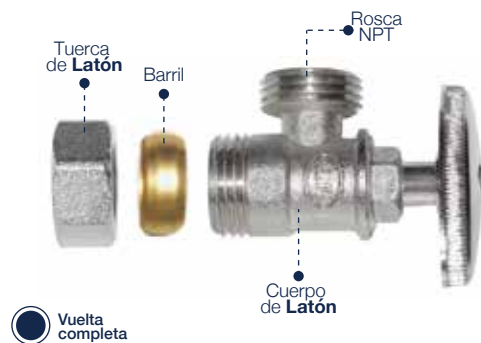

CLAVE	C/M	MEDIDA
P-31-13	10/210	1/2"

VÁLVULA ANGULAR DE BARRIL



CLAVE	C/M	MEDIDA
P-32-13	20/220	1/2"



VÁLVULA ANGULAR

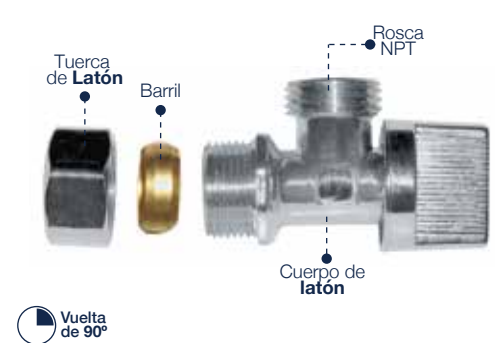

CLAVE	C/M	MEDIDA
XP-31-13	10/210	1/2"

VÁLVULA ANGULAR

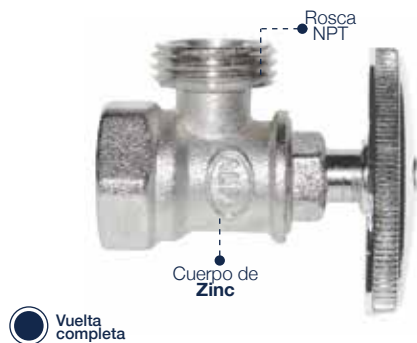

CLAVE	C/M	MEDIDA
XP-40-13	20/220	1/2"

VÁLVULA ANGULAR



CLAVE	C/M	MEDIDA
XP-41-13	20/220	1/2"

BIDET

PARA W.C. O REGADERA.

- Práctico y cómodo.
- Fácil instalación.



CLAVE	C/M	MEDIDA
XK-BID-02	1/1	1.25 m

ESPEJO DE VANIDAD

- Sistema multiposiciones.
- Empotrable.
- Base vertical.
- Con aumento.
- Cromado.



CLAVE	C/M	MEDIDA
XK-EVR-127	1/20	6"

ESPEJO DE VANIDAD

- Sistema multiposiciones.
- Empotrable.
- Base redonda.
- Con aumento.
- Cromado.



CLAVE	C/M	MEDIDA
XK-EVR-152	1/20	6"

ESPEJO DE VANIDAD

- Cuerpo de latón.
- Cubrimiento de acero inoxidable 304.
- Con base.
- Con aumento.
- Cromado.



CLAVE	C/M	MEDIDA
XK-EVR-128	1/20	6"

FLÉXICO

PARA LAVABO, FREGADERO Y W.C.

- Manguera de EPDM.
- Trenzado de aluminio.
- Con tuerca metálica.
- Inserto de nylon.
- Presión max: 145 PSI.
- Temperatura: 80°C



CLAVE	C/M	MEDIDA
XK-22-35	5/200	WC - 35cm
XK-13-40	5/200	LAV-40 cm
XK-13-55	5/200	FREG - 55cm

FLÉXICO

PARA LAVABO, FREGADERO

- Manguera de EPDM.
- Trenzado de aluminio.
- Con tuerca de latón.
- Inserto de latón.
- Presión max: 145 PSI.
- Temperatura: 80°C



CLAVE	C/M	MEDIDA
XK-L13-40	5/100	40 cm
XK-L13-55	5/200	55 cm
XK-L13-100	5/100	100 cm

FLÉXICO

PARA MONOMANDO

- Manguera de EPDM.
- Trenzado de aluminio.
- Con tuerca metálica.
- Inserto de latón.
- Presión max: 145 PSI.
- Temperatura: 80°C



CLAVE	C/M	MEDIDA
XK-MN-FLX	2/200	40 cm

FLÉXICO Y

PARA MEZCLADORA

- Manguera de EPDM.
- Trenzado de aluminio.
- Con tuerca metálica.
- Inserto de latón.
- Presión max: 145 PSI.
- Temperatura: 80°C



CLAVE	C/M	MEDIDA
XK-13-55Y	1/80	55 cm

VINIALFA

FLÉXICO PARA LAVABO Y FREGADERO

- Manguera de EPDM.
- Trenzado de vinil.
- Con tuerca de latón.
- Inserto de latón.
- Presión max: 145 PSI.
- Temperatura: 80°C



CLAVE	C/M	MEDIDA
XK-V13-40	5/200	40 cm
XK-V13-55	5/200	55 cm
XK-V13-100	5/100	100 cm

ALFAINOX

FLÉXICO PARA LAVABO Y FREGADERO

- Manguera de EPDM.
- Trenzado de acero inoxidable.
- Con tuerca de latón.
- Inserto de latón.
- Presión max: 145 PSI.
- Temperatura: 80°C

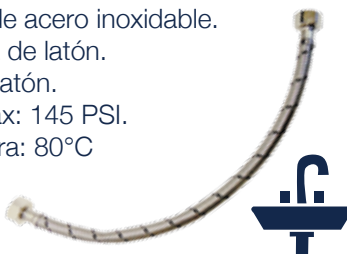

CLAVE	C/M	MEDIDA
XK-S13-40	5/200	40 cm
XK-S13-55	5/200	55 cm
XK-S13-100	5/100	100 cm

VINIALFA

FLÉXICO PARA WC

- Manguera de EPDM.
- Trenzado de vinil.
- Con tuerca de latón.
- Inserto de latón.
- Presión max: 145 PSI.
- Temperatura: 80°C



CLAVE	C/M	MEDIDA
XK-V22-35	5/200	35cm
XK-V22-50	5/200	50cm
XK-V22-60	5/200	60cm

ALFAINOX

FLÉXICO PARA WC

- Manguera de EPDM.
- Trenzado de acero inoxidable.
- Con tuerca de latón.
- Inserto de latón.
- Presión max: 145 PSI.
- Temperatura: 80°C

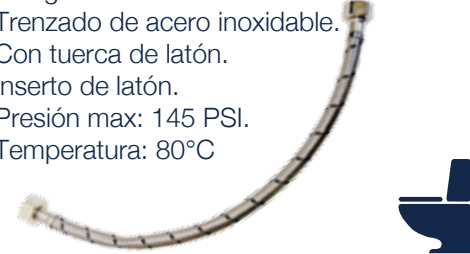

CLAVE	C/M	MEDIDA
XK-S22-35	5/200	35cm
XK-S22-50	5/200	50cm
XK-S22-60	5/200	60cm

FLÉXICOS

ALUFLEX

FLÉXICO PARA WC

- Manguera de EPDM.
- Trenzado de aluminio.
- Con tuerca de latón.
- Inserto de latón.
- Presión max: 145 PSI.
- Temperatura: 80°C



CLAVE	C/M	MEDIDA
XK-L22-35	5/200	WC-35 cm
XK-L22-50	5/200	50 cm
XK-L22-60	5/200	60 cm

ALFAINOX

FLÉXICO PARA WC

- Manguera de EPDM.
- Trenzado de acero inoxidable.
- Con tuerca de latón y plástico.
- Inserto de latón.
- Presión max: 145 PSI.
- Temperatura: 80°C



CLAVE	C/M	MEDIDA
XK-S22-P35	5/200	35cm

VINIALFA

FLÉXICO PARA WC

- Manguera de EPDM.
- Trenzado de vinil.
- Con tuerca de latón y plástico.
- Inserto de latón.
- Presión max: 145 PSI.
- Temperatura: 80°C



CLAVE	C/M	MEDIDA
XK-V22-P35	1/1	35cm

ALUFLEX

FLÉXICO PARA WC

- Manguera de EPDM.
- Trenzado de aluminio.
- Con tuerca de latón.
- Inserto de latón.
- Presión max: 145 PSI.
- Temperatura: 80°C

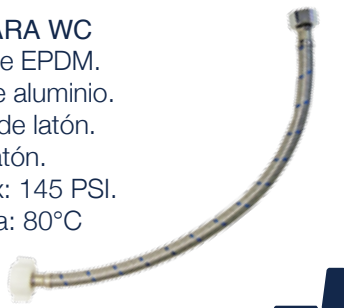

CLAVE	C/M	MEDIDA
XK-22-P35	1/1	35cm

ALFAINOX

MANGUERA PARA USOS GENERALES

- Manguera de NBR.
- Trenzado de acero inoxidable.
- Con tuerca de latón 3/8"
- Inserto de latón.
- Presión max: 1 PSI.
- Temperatura: 60°C



CLAVE	C/M	MEDIDA
XGF-S6-060	50/100	60cm
XGF-S6-100	50/100	100cm
XGF-S6-150	25/50	150cm
XGF-S6-200	25/50	200cm
XGF-S6-300	20/40	300cm
XGF-S6-500	15/30	500cm

VINIALFA

MANGUERA PARA USOS GENERALES

- Manguera de NBR.
- Trenzado de vinil.
- Con tuerca de latón 3/8"
- Inserto de latón.
- Presión max: 1 PSI.
- Temperatura: 60°C



CLAVE	C/M	MEDIDA
XGF-V6-060	10/100	60cm
XGF-V6-100	10/100	100cm
XGF-V6-150	10/50	150cm
XGF-V6-200	10/50	200cm
XGF-V6-300	10/40	300cm
XGF-V6-500	10/30	500cm

MANGUERA

PARA USOS GENERALES

- De 3/8"
- Manguera NBR.
- Trenzado de aluminio.
- Con tuerca de latón.
- Presión máx. 1PSI.
- Temp. max.: 60°C.



CLAVE	C/M	MEDIDA
XGF-06-060	10/100	60 cm
XGF-06-100	10/100	100 cm
XGF-06-150	10/50	150 cm
XGF-06-200	10/50	200 cm
XGF-06-300	10/40	300 cm
XGF-06-500	10/30	500 cm

MANGUERA

PARA USOS GENERALES

- De 5/16"
- Manguera NBR.
- Trenzado de aluminio.
- Con tuerca de latón.
- Presión máx. 1PSI.
- Temp. max.: 40°C.



CLAVE	C/M	MEDIDA
XGF-06-06M	10/100	60 cm
XGF-06-20M	10/50	200 cm
XGF-06-50M	5/25	500 cm

PIGTAIL

- De 3/8"
- Para gas.
- En Aluminio.
- Temp. max.: 40°C.



CLAVE	C/M	MEDIDA
XGF-06-050	10/100	50 cm

FLÉXICO

- Para boiler.
- Longitud: 60 cm.



CLAVE	C/M	MEDIDA
XK-13-60HT	5/100	1/2"x3/4"
XK-19-60HT	5/100	3/4"x3/4"
XK-13-90HT	5/60	1/2"x3/4"
XK-14-90HT	5/60	1/2"x3/4"



LÍNEA INSTITUCIONAL

DESPACHADOR

DE TOALLAS INTERDOBLADAS

- De plástico ABS de alto impacto.
- Medidas: 20.6x27.8x10.2 cm.



CLAVE	C/M	COLOR
XHP-01	2/2	BLANCO

DESPACHADOR DE PAPEL

- De plástico ABS de alto impacto.
- Capacidad: 1 rollo de 9".
- Medidas: 28x26.3x13.4 cm.



CLAVE	C/M	COLOR
XHP-02	2/2	HUMO
XHP-02B	2/2	BLANCO

DESPACHADOR DE TOALLAS

- De plástico ABS de alto impacto.
- Capacidad: 1 rollo de 8".
- Medidas: 34x26x27.5 cm.



CLAVE	C/M	COLOR
XHP-06	1/1	HUMO
XHP-06B	1/1	BLANCO

DESPACHADOR DE PAPEL

- De plástico ABS de alto impacto.
- Capacidad: 1 rollo de 9.5 cm.
- Medidas: 13.8x13.3x12.5 cm.



CLAVE	C/M	COLOR
XHP-04	1/1	BLANCO

DESPACHADOR DE PAPEL

- De plástico ABS de alto impacto.
- Capacidad: 1 rollo de 12".
- Medidas: 34.3x34.5x13.4 cm.



CLAVE	C/M	COLOR
XHP-03	2/2	BLANCO

DESPACHADOR DE TOALLAS INTERDOBLADAS

- De plástico ABS de alto impacto.
- Capacidad: 600 toallas.
- Medidas: 31.7x27.3x12.1 cm.



CLAVE	C/M	COLOR
XHP-05	2/2	BLANCO

DESPACHADOR DE JABÓN LIQUIDO

- De plástico ABS de alto impacto.
- Capacidad: 800 ml.
- Medidas: 19.5x12.5x9 cm.



CLAVE	C/M	COLOR
XJL-01-80	1/17	BLANCO

DESPACHADOR DE JABÓN LIQUIDO

- De plástico ABS de alto impacto.
- Capacidad: 300 ml.
- Medidas: 16x10.8x8 cm.



CLAVE	C/M	COLOR
XJL-03-80	1/1	BLANCO

DESPACHADOR DE JABÓN LÍQUIDO

- De polipropileno.
- Capacidad: 800 ml.
- Medidas: 19.5x12.5x9 cm.
- Rellenable.



CLAVE	C/M	COLOR
XJL-02-80	1/1	BLANCO

TAPETA PARA MINGITORIO

- Con pastilla integrada.
- Caja con 12 piezas.



CLAVE	C/M	MEDIDA
XRM-01	1/1	17 cm

TAPETA PARA MINGITORIO

- Con aroma integrado.
- Caja con 12 piezas.



CLAVE	C/M	MEDIDA
XTM-01	1/1	17 cm

CARTUCHO Y DOSIFICADOR

- Automático.
- En aerosol.



CLAVE	C/M	CONCEPTO
XJR-02-08	1/1	DOSIFICADOR
XJR-00	12/12	CARTUCHO



MEZCLADORAS COCINA

MEZCLADORA PARA FREGADERO

- Manerales QUEEN.
- Cuerpo ABS.

ídrop

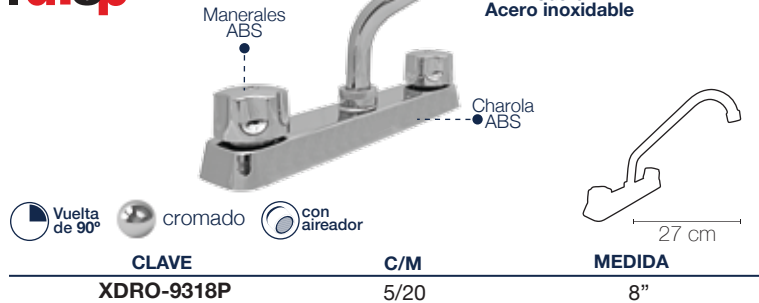

MEZCLADORA PARA FREGADERO

- Manerales PIRULI.
- Cuerpo de ABS.

ídrop



MEZCLADORA PARA FREGADERO

- Manerales CRUZETA.
- Cuerpo ABS con inserto de aluminio.

ídrop



MEZCLADORA PARA FREGADERO

- Manerales ITALIA.
- Cuerpo ABS con inserto de aluminio.

ídrop

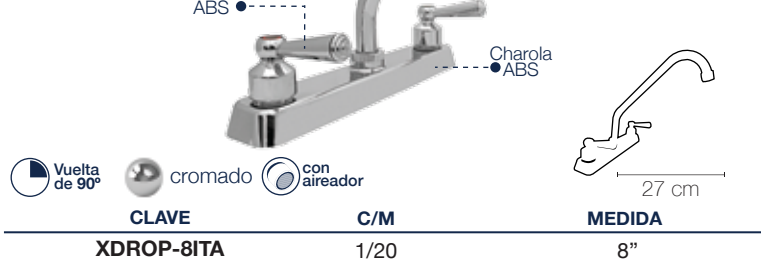

MEZCLADORA PARA FREGADERO

- Manerales QUEEN.
- Cuerpo plástico con aluminio color latón.

ídrop

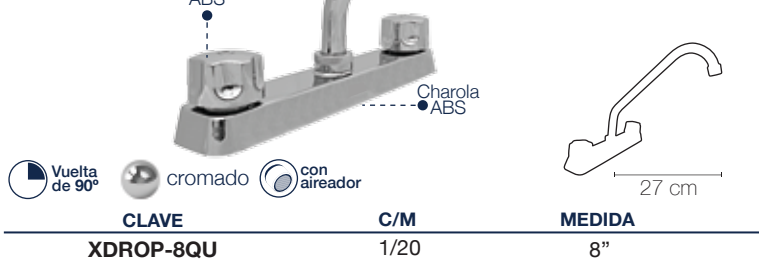

LLAVE INDIVIDUAL PARA FREGADERO

- De latón.

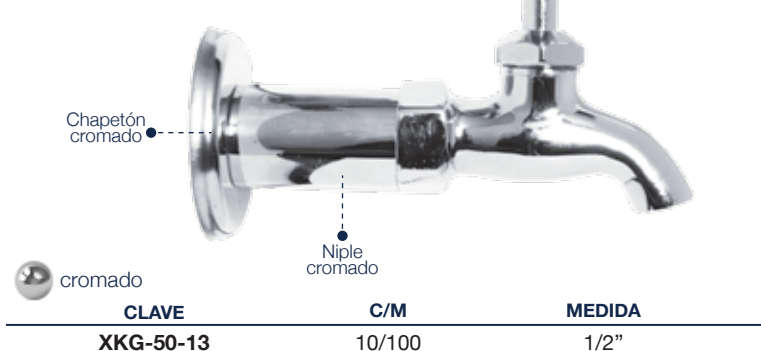

MEZCLADORA PARA FREGADERO

- Manerales QUEEN.
- Cuerpo de latón.



MEZCLADORA PARA FREGADERO

- Manerales QUEEN.
- Cuerpo de latón.

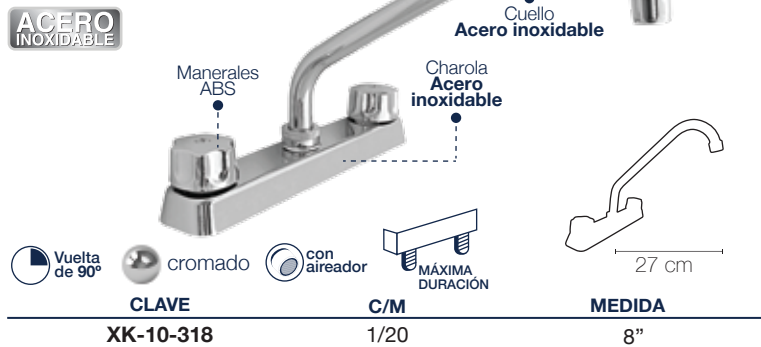

CLAVE **C/M** **MEDIDA**

XK-10-318 **1/20** **8"**

MEZCLADORA PARA FREGADERO

- Manerales QUEEN.
- Cuerpo de latón.

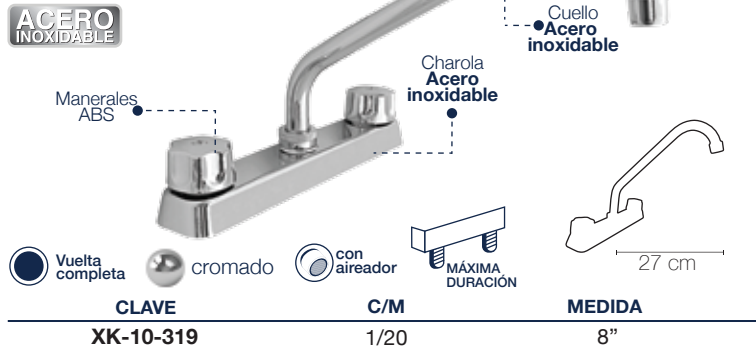

CLAVE **C/M** **MEDIDA**

XK-10-319 **1/20** **8"**

MEZCLADORA PARA FREGADERO

- Manerales PIRULI.
- Cuerpo de latón.



CLAVE **C/M** **MEDIDA**

XK-11-318 **1/20** **8"**

MEZCLADORA PARA FREGADERO

- Manerales HARLEY.
- Cuerpo de latón.



CLAVE **C/M** **MEDIDA**

X8-H10-KA0 **1/20** **8"**

MEZCLADORA PARA FREGADERO

- Manerales KING.
- Cuerpo de latón.

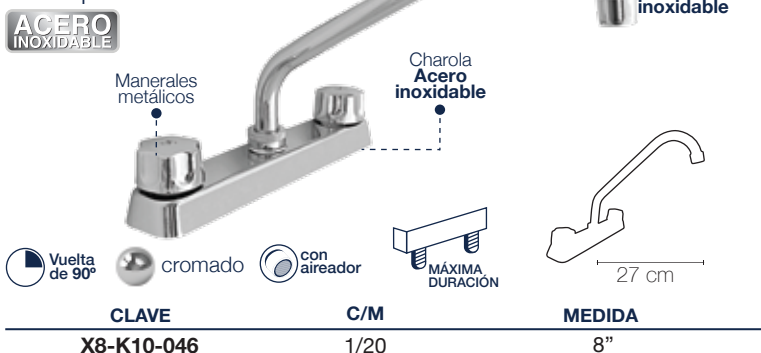

CLAVE **C/M** **MEDIDA**

X8-K10-046 **1/20** **8"**

MEZCLADORA PARA FREGADERO

- Manerales ITALIA.
- Cuerpo de latón.



CLAVE **C/M** **MEDIDA**

X8-Y10-KB9 **1/16** **8"**

MEZCLADORA PARA FREGADERO

- Cuerpo latón.



CLAVE **C/M** **MEDIDA**

X8-CUR-318 **1/20** **8"**

MEZCLADORA PARA FREGADERO

- Manerales metálicos OLD ANTIQUE.
- Cuerpo de latón.

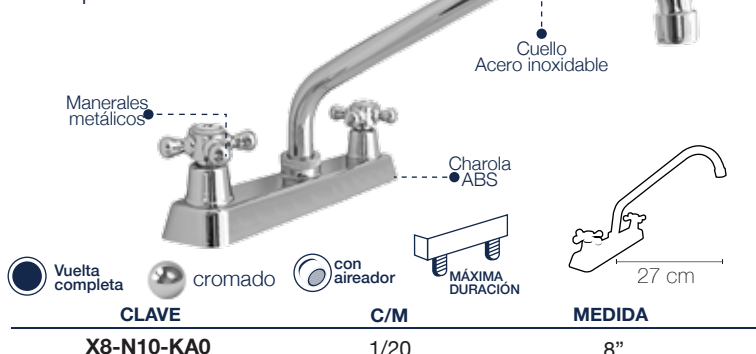

CLAVE **C/M** **MEDIDA**

X8-N10-KA0 **1/20** **8"**

MEZCLADORA PARA FREGADERO

- Cuerpo **latón**.
- 2 funciones.



producto MEJORADO

MEZCLADORA PARA FREGADERO

- Cuerpo **latón**.
- 2 funciones.



producto MEJORADO

MEZCLADORA PARA FREGADERO

- Cuerpo **latón**.



MEZCLADORA PARA FREGADERO

- Manerales OLD ANTIQUE.
- Cuerpo de **latón**.

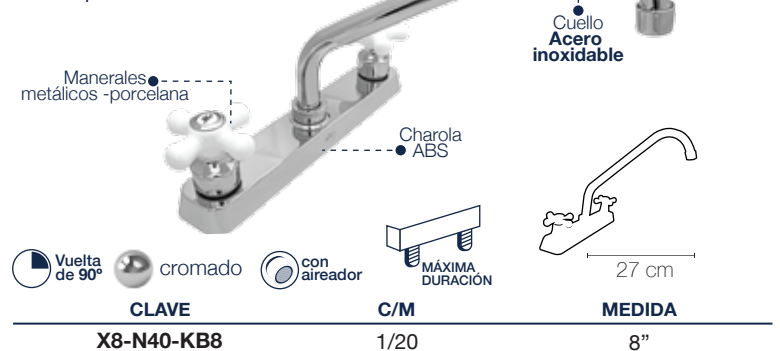

MEZCLADORA PARA FREGADERO

- Manerales PIRULI.
- Cuerpo de **latón**.

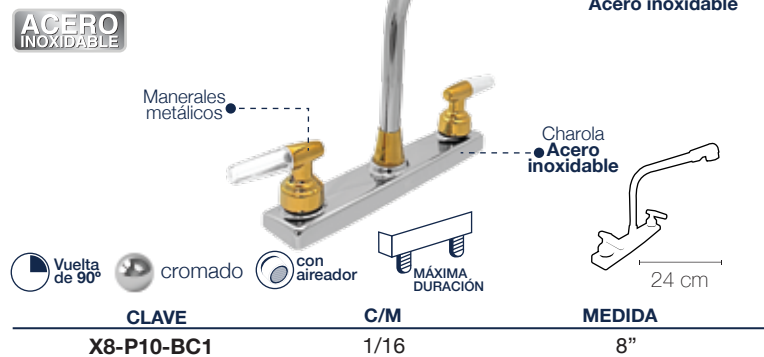

MEZCLADORA PARA FREGADERO

- Cuerpo de **latón**.



alfa
NUEVO
PROX.
ABR

MEZCLADORA PARA FREGADERO

- Manerales ATENAS.
- Cuerpo de **latón**.

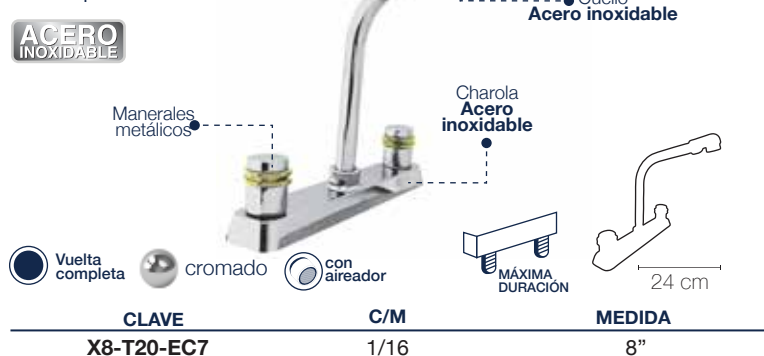

MEZCLADORA PARA FREGADERO

- Manerales metálicos.
- Cuerpo de **latón**.

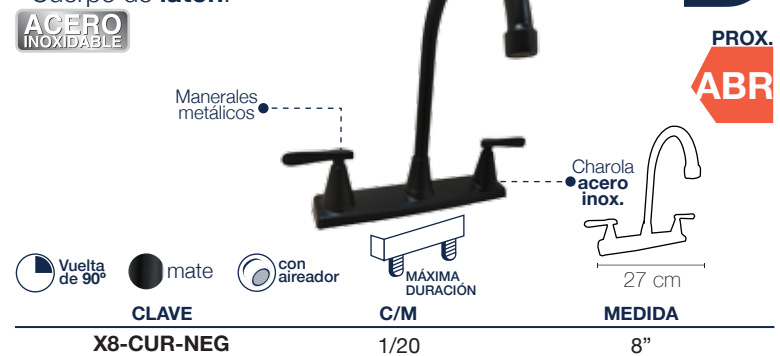

alfa
NUEVO
PROX.
ABR

MEZCLADORA PARA FREGADERO

- Cuerpo **latón**.



CLAVE	C/M	MEDIDA
X8-C10-318	1/16	8"

MEZCLADORA PARA FREGADERO

- Cuerpo **latón**.



CLAVE	C/M	MEDIDA
X8-Z10-318	1/20	8"

MEZCLADORA PARA FREGADERO

- Manerales ANTIGUA.
- Cuerpo de **latón**.

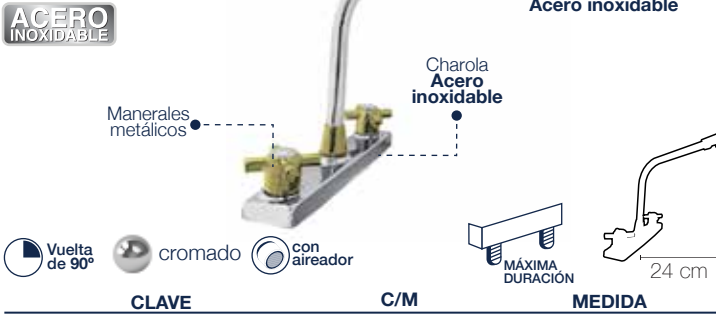

CLAVE	C/M	MEDIDA
X8-N10-BC1	1/12	8"

MEZCLADORA PARA FREGADERO

- Cuerpo **latón**.



CLAVE	C/M	MEDIDA
X8-CUR-CIS	1/10	8"

MEZCLADORA PARA FREGADERO

- Manerales ATENAS.
- Cuerpo de **latón**.



CLAVE	C/M	MEDIDA
X8-T30-EC7	1/16	8"

MEZCLADORA PARA FREGADERO

- Cuerpo **latón**.



CLAVE	C/M	MEDIDA
X8-Z10-CIS	1/16	8"

MEZCLADORA PARA FREGADERO

- Manerales DERBY.
- Cuerpo de **latón**.



CLAVE	C/M	MEDIDA
X8-P10-CB1	1/12	8"

MEZCLADORA PARA FREGADERO

- Cuerpo **latón**.



CLAVE	C/M	MEDIDA
X8-ANE-CIS	1/10	8"

MEZCLADORA PARA FREGADERO

- Cuerpo latón.

ACERO INOXIDABLE



CLAVE	C/M	MEDIDA
X8-ANG-CIS	1/16	8"

MEZCLADORA PARA FREGADERO

- Manerales DERBY.

- Cuerpo de latón.

ACERO INOXIDABLE



CLAVE	C/M	MEDIDA
X8-P10-CNI	1/12	8"

MEZCLADORA PARA FREGADERO

- Cuerpo latón.

- Para empotrar.



CLAVE	C/M	MEDIDA
X8-EMP-318	1/20	8"

MEZCLADORA PARA FREGADERO

- Cuerpo latón.

ACERO INOXIDABLE



CLAVE	C/M	MEDIDA
X8-ACU-CIS	1/12	8"

MEZCLADORA PARA FREGADERO

- Cuerpo latón.

ACERO INOXIDABLE



CLAVE	C/M	MEDIDA
X8-ANG-CSA	1/12	8"

MEZCLADORA PARA FREGADERO

- Cuerpo de latón.

ACERO INOXIDABLE



CLAVE	C/M	MEDIDA
X8-CUA-CR	1/10	8"

MEZCLADORA PARA FREGADERO

- Cuerpo de latón.

ACERO INOXIDABLE



CLAVE	C/M	MEDIDA
X8-GAR-CR	1/10	8"

MEZCLADORA PARA FREGADERO

- Cuerpo de latón.

ACERO INOXIDABLE



CLAVE	C/M	MEDIDA
X8-CUA-SA	1/10	8"

MEZCLADORA PARA FREGADERO

- Cuerpo de latón.

ACERO INOXIDABLE



CLAVE	C/M	MEDIDA
X8-GAR-SA	1/10	8"

MONOMANDO PARA FREGADERO



CLAVE	C/M
XK-MN-022	1/20

MONOMANDO PARA FREGADERO



CLAVE	C/M	MEDIDA
XK-MN-007	1/20	33cm

MONOMANDO PARA FREGADERO



CLAVE	C/M	MEDIDA
XK-MNS-07	1/20	33cm

MONOMANDO PARA FREGADERO

- Cuerpo de acero inoxidable.
- 2 funciones.



CLAVE	C/M	MEDIDA
XK-MN-RES	1/10	8"

MONOMANDO PARA FREGADERO

- Cuerpo de acero inoxidable.
- 2 funciones.



CLAVE	C/M	MEDIDA
XK-MN-CM2	1/10	8"

MONOMANDO PARA FREGADERO

- Cuerpo de acero inoxidable.



CLAVE	C/M	MEDIDA
XK-MN-COB	1/10	8"

MONOMANDO PARA FREGADERO

- Cuerpo de acero inoxidable.

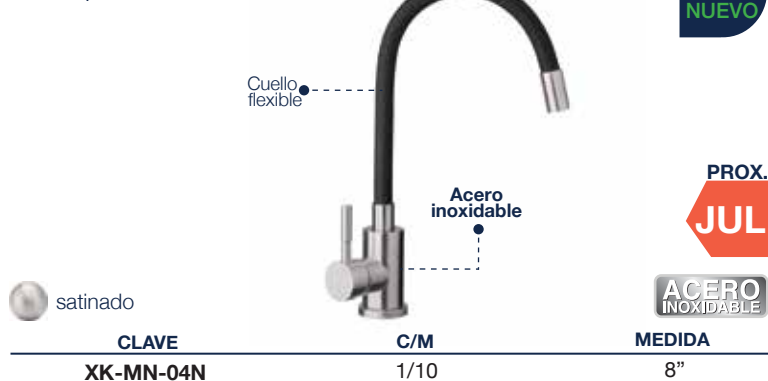

CLAVE	C/M	MEDIDA
XK-MN-04N	1/10	8"

MONOMANDO PARA FREGADERO



CLAVE	C/M
XK-MNN-07	1/12

MONOMANDO PARA FREGADERO

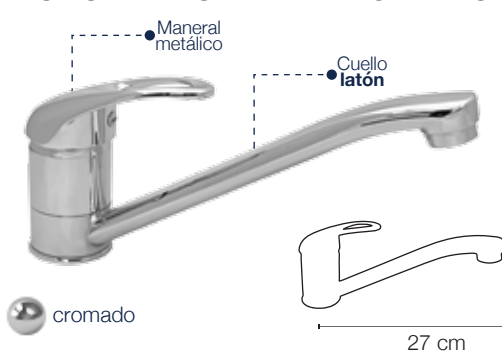

CLAVE	C/M
XK-MN-F01	1/12

MONOMANDO PARA FREGADERO



CLAVE	C/M	MEDIDA
XK-MN-REG	1/10	8"

MONOMANDO PARA FREGADERO

- Cartucho cerámico.
- 50 cm de altura.
- Disponible en 4 colores.



CLAVE	C/M	COLOR
XK-MN-03A	1/5	AZUL
XK-MN-03B	1/5	BLANCO
XK-MN-03N	1/5	NEGRO
XK-MN-03R	1/5	ROJO

MONOMANDO PARA FREGADERO

- Con pre-lavado.
- Para mueble.
- No retráctil.



CLAVE	C/M	MEDIDA
XK-MN-018	1/6	60 cm/altura

MONOMANDO PARA FREGADERO

- Con pre-lavado.
- Para mueble.
- No retráctil.



CLAVE	C/M	MEDIDA
XK-MN-019	1/6	60 cm/altura

MONOMANDO PARA FREGADERO

- Con pre-lavado para mueble.



CLAVE	C/M	MEDIDA
XK-MN-021	1/5	8"



TARJAS

TARJA SENCILLA PARA MONOMANDO

- Para contracranasta.
- Sin escurridor.
- Espesor 0.68 mm.
- Calibre 23.



CLAVE	C/M	MEDIDA
OS-101C	5/5	64 x 56 cm



¿CÓMO ESCOGER UNA TARJA?

VERSIÓN

TARJA IZQUIERDA



El escurridor es el que determina la versión de la tarja

TARJA DERECHA



INSTALACIÓN

TARJA DE SOBREPONER



Con ceja para instalar en pared o en mueble

TARJA DE SUBMONTAR



Sin ceja, para instalar en mueble

TARJA DE EMPOTRAR



Sin ceja, para instalar en mueble

TIPO DE DESAGÜE

CONTRACANASTA



Diámetro de desagüe es

4"

CONTRAREJILLA

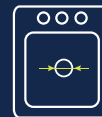

Diámetro de desagüe es

2"

TARJA INDIVIDUAL

- Material 201.
- Calibre 24.
- Espesor 0.57 mm.



satinado

CLAVE	C/M	MEDIDA
XTA-38-EM	1/5	38.5x38.5x14cm

TARJA DOBLE PARA MONOMANDO

- Sin escurridor.
- Espesor 0.68 mm
- Para contracanasta.
- Calibre 23.



satinado

CLAVE	C/M	MEDIDA
RB-001	6/6	87 x 45cm

TARJA DE SOBREPONER

- Con ceja.
- Para contracanasta
- Calibre 24.
- Espesor 0.61 mm.



CLAVE	C/M	VERSIÓN	MEDIDA
XTA-81-IZQ	5/5	IZQUIERDA	80 x 50cm
XTA-81-DER	5/5	DERECHA	80 x 50cm

TARJA DE SOBREPONER PARA MONOMANDO

- Para monomando.
- Para contracanasta.
- Con ceja.
- Espesor 0.61 mm.
- Calibre 24.



CLAVE	C/M	VERSIÓN	MEDIDA
XTA-81-MDE	5/5	DERECHA	80 x 50cm
XTA-81-MIZ	5/5	IZQUIERDA	80 x 50cm

TARJA DE EMPOTRAR

- Sin ceja.
- Para contracanasta.
- Calibre 24.
- Espesor 0.61 mm.



CLAVE	C/M	VERSIÓN	MEDIDA
XTA-82-IZQ	5/5	IZQUIERDA	80 x 50cm
XTA-82-DER	5/5	DERECHA	80 x 50cm

TARJA DE SOBREPONER PARA LA INSTALACIÓN DE FILTROS

- Con ceja.
- Con orificio para grifo.
- Para contracanasta.
- Espesor 0.61 mm.
- Calibre 24.



CLAVE	C/M	VERSIÓN	MEDIDA
XTA-83-IZQ	5/5	IZQUIERDA	80 x 50cm
XTA-83-DER	5/5	DERECHA	80 x 50cm

TARJA DE SOBREPONER CON DESAGÜE DE 2"

- Con ceja.
- Para contrarejilla.
- Calibre 24.
- Espesor 0.61 mm.



CLAVE	C/M	VERSIÓN	MEDIDA
XTA-84-IZQ	5/5	IZQUIERDA	80 x 50cm
XTA-84-DER	5/5	DERECHA	80 x 50cm

TARJA DE EMPOTRAR

- Sin ceja.
- Para contracanasta.
- Calibre 24.
- Espesor 0.61 mm.



CLAVE	C/M	VERSIÓN	MEDIDA
XTA-100IEM	5/5	IZQUIERDA	100 x 50cm
XTA-100DEM	5/5	DERECHA	100 x 50cm

TARJA DE SOBREPONER

- Con ceja.
- Para contracanasta.
- Calibre 24.
- Espesor 0.61 mm.



CLAVE	C/M	VERSIÓN	MEDIDA
XTA-100IZQ	5/5	IZQUIERDA	100 x 50cm
XTA-100DER	5/5	DERECHA	100 x 50cm

TARJA

- DOBLE
- Material 201.
- Calibre 23.
- Espesor 0.68 mm.



satinado

CLAVE	C/M	MEDIDA
XTA-84D-EM	1/5	84x56x13.5cm

TARJA DE EMPOTRAR

- DOBLE
- Material SS 201.
- Calibre 23.
- Espesor 0.68 mm.



satinado - Incluye 10 grapas para montaje.

CLAVE	C/M	VERSIÓN	MEDIDA
XTA-12DDEM	1/5	DERECHA	120 x 50 x 16cm
XTA-12DIEM	1/5	IZQUIERDA	120 x 50 x 16cm

TARJA DE EMPOTRAR

- DOBLE
- Material SS 201.
- Calibre 23.
- Espesor 0.68 mm.



satinado - Incluye 10 grapas para montaje.

CLAVE	C/M	VERSIÓN	MEDIDA
XTA-12DGDE	1/5	DERECHA	120 x 50 x 16cm
XTA-12DGIE	1/5	IZQUIERDA	120 x 50 x 16cm

TARJA DE SUBMONTAR

- DOBLE
- Material 304.
- Calibre 20.
- Espesor 0.91 mm.



satinado

CLAVE	C/M	MEDIDA
XTA-80D-SB	1/5	80 x 52 x 23cm

TARJA DE SUBMONTAR

- DOBLE
- Material 304.
- Calibre 20.
- Espesor 0.91 mm.



satinado

CLAVE	C/M	MEDIDA
XTA-82D-SB	1/5	82 x 46 x 23cm

TARJA DE SUBMONTAR

- DOBLE
- Material 304.
- Calibre 19.
- Espesor 1.06 mm.



satinado

CLAVE	C/M	MEDIDA
XTA-33D-SB	1/5	83 x 48 x 22cm

TARJA DE SUBMONTAR

- Material SS 304.
- Incluye contracanasta.
- Fabricada a mano.
- Calibre 18.
- Espesor 1.2mm.



satinado - incluye grapas de sujeción

CLAVE	C/M	MEDIDA
XTA-50-45	1/5	50 x 45 x 23 cm



TARJA DE SUBMONTAR

- Material SS 304.
- Incluye contracanasta.
- Fabricada a mano.
- Calibre 18.
- Espesor 1.2mm.



mate - incluye grapas de sujeción

CLAVE	C/M	MEDIDA
XTA-50-45N	1/5	50 x 45 x 23 cm



TARJA DOBLE DE SUBMONTAR

- Material SS 304.
- Incluye 2 contracanastas.
- Fabricada a mano.
- Calibre 18.
- Espesor 1.2mm.



satinado

CLAVE	C/M	MEDIDA
XTA-78-45	1/5	78 x 45 x 23 cm



TARJA DOBLE DE SUBMONTAR

- Material SS 304.
- Incluye 2 contracanastas.
- Fabricada a mano.
- Calibre 18.
- Espesor 1.2mm.



mate

CLAVE	C/M	MEDIDA
XTA-78-45N	1/5	78 x 45 x 23 cm



PORTA GARRAFÓN



CLAVE	C/M	COLOR
XK-PORG-BC	1/1	BCO/AZUL

DESPACHADOR DE JABÓN

- Para tarja.



CLAVE	C/M	ACABADO
ZY-001	1/1	CROMADO

PARRILLA PORTÁTIL

1 QUEMADOR



CLAVE	C/M	DETALLES
XES-PORT	1/6	PARA GAS BUTANO

FILTRO ALTO RENDIMIENTO CON CARTUCHO LAVABLE

- 99% de partículas iguales o mayores a 5 micras.
- Arena, tierra y sedimentos.
- Ideal para zonas con alta concentración de sedimentos.
- Evita que se tapen las tuberías y regaderas.

- Filtro de repuesto.
- Filtro para toma domiciliaria y bajo tarja.



CLAVE	C/M	COLOR
XK-FIL-01	1/1	NEGRO
XK-FIL-01R	1/1	n/a

FILTRO SOBRE TARJA CON CARTUCHO LAVABLE

- Retiene el 99% de bacterias.
- Elimina el sabor a cloro.
- Mejora el sabor, color y olor del agua.
- 1 repuesto = 120 garrafones = 2,400 L
- Durabilidad del cartucho: 6 meses.

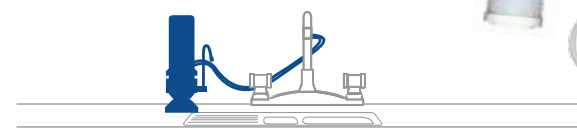

CLAVE	C/M	DETALLES
XK-FIL-02	1/1	FILTRO
XK-FIL-02R	1/1	CARTUCHO

FILTRO BAJO TARJA CON GRIFO Y CARTUCHO

- Retiene el 99% de bacterias.
- Elimina el sabor a cloro.
- Mejora el sabor, color y olor del agua.
- 1 repuesto = 120 garrafones = 2,400 L
- Durabilidad del cartucho: 6 meses.

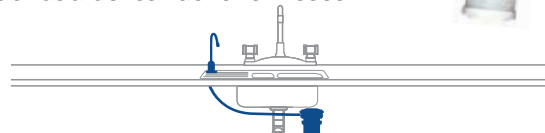

CLAVE	C/M	DETALLES
XK-FIL-03	1/1	FILTRO
XK-FIL-02R	1/1	CARTUCHO

SUAVIZADOR PROSOFT OLYMPIA

- Protege tuberías, lavadora y caldera de la formación de sarro.
- Caudal de 3000 lt./hr.
- Con válvula electrónica automática.
- Incluye Bypass
- Bajo consumo de agua y sal.



CLAVE	C/M	COLOR
XK-FILPROS	1/1	GRIS

SUAVIZADOR KEOPS

- Protege tuberías, lavadora y caldera de la formación de sarro.
- Caudal de 3000 lt./hr.
- Incluye Bypass
- Bajo consumo de agua y sal.



CLAVE	C/M	COLOR
XK-FILKEOP	1/1	BEIGE

Provee **agua purificada** a través de **5 etapas** que purifican, evitando virus, bacterias, metales pesados, sales, etc.

alfa tiene la solución para que ya no cargue, compre, ni vacíe pesados garrafones.

NO MÁS GARRAFONES



SISTEMA DE PURIFICACIÓN

PURIFICADOR BRAVO ECO

SISTEMA DE PURIFICACIÓN EN 5 ETAPAS.

- Elimina: virus, bacterias, metales pesados y sedimentos.
- Reduce: sales, sustancias químicas y orgánicas.
- Funcionamiento automático.
- Purifica 185 L de agua al día.
- Indicador digital de operación.
- Incluye kit de instalación y grifo dispensador.

- 1** FILTRO DE SEDIMENTOS
- 2** FILTRO DE CARBÓN ACTIVADO
- 3** FILTRO DE POLIPROPILENO
- 4** FILTRO DE CARBÓN ACTIVADO SECUNDARIO
- 5** MEMBRANA DE ÓSMOSIS INVERSA



CLAVE	C/M	COLOR
XK-FILBECO	1/1	BLANCO

SISTEMA DE PURIFICACIÓN

PURIFICADOR BRAVO PLUS

SISTEMA DE PURIFICACIÓN EN 5 ETAPAS.

- Elimina: virus, bacterias, metales pesados y sedimentos.
- Reduce: sales, sustancias químicas y orgánicas.
- Funcionamiento automático.
- Purifica 185 L de agua al día.
- Indicador digital de operación.
- Incorpora sistema de detección de fugas en el purificador, sistema de medición de calidad del agua y alarma de mal funcionamiento.
- Incluye kit de instalación y grifo dispensador.

- 1** FILTRO DE SEDIMENTOS
- 2** FILTRO DE CARBÓN ACTIVADO
- 3** FILTRO DE POLIPROPILENO
- 4** FILTRO DE CARBÓN ACTIVADO SECUNDARIO
- 5** MEMBRANA DE ÓSMOSIS INVERSA

LÁMPARA DE ESTERILIZACIÓN UV



CLAVE	C/M	COLOR
XK-FILBPLU	1/1	BEIGE



**Y
CESPOL
CONTRAS**

CESPOL PARA FREGADERO - De PVC.



CLAVE	MEDIDA	C/M
XK-10-203F	STD	GRANEL

CESPOL PARA FREGADERO - De PVC.



CLAVE	MEDIDA	C/M
XK-10-202	STD	1/1

CESPOL PARA FREGADERO - De PP.

- Medida STD



CLAVE	DETALLES	C/M
XK1187CBR	S/CUBIERTA	GRANEL
XK1187CBC	C/CUBIERTA	GRANEL

CESPOL PARA FREGADERO - De PP.

- Medida STD

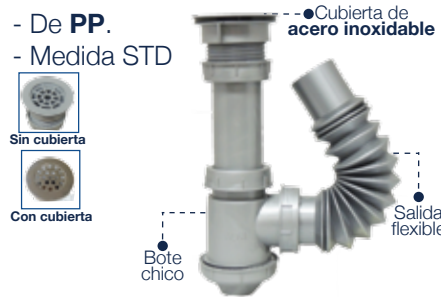

CLAVE	DETALLES	C/M
XK1187CGR	S/CUBIERTA	GRANEL
XK1187CGC	C/CUBIERTA	GRANEL

CESPOL PARA FREGADERO - De PP.

- Medida STD



CLAVE	DETALLES	C/M
XK1191GBR	S/CUBIERTA	GRANEL
XK1191GBC	C/CUBIERTA	GRANEL

CESPOL PARA FREGADERO - De PP.

- Medida STD

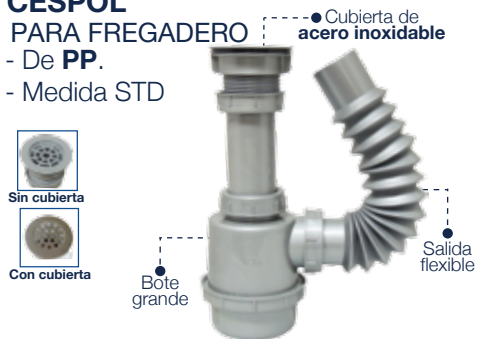

CLAVE	DETALLES	C/M
XK1191GGR	S/CUBIERTA	GRANEL
XK1191GGC	C/CUBIERTA	GRANEL

CESPOL PARA FREGADERO - De PP.

- Medida STD



CLAVE	DETALLES	C/M
XK11233BR	S/CUBIERTA	GRANEL
XK11233BC	C/CUBIERTA	GRANEL

CESPOL PARA FREGADERO - De PP.

- Medida STD



CLAVE	DETALLES	C/M
XK11233GR	S/CUBIERTA	GRANEL
XK11233GC	C/CUBIERTA	GRANEL

CESPOL PARA FREGADERO - De PP.

- Medida STD



CLAVE	DETALLES	C/M
XK11502BO	S/CUBIERTA	GRANEL
XK11502BP	C/CUBIERTA	GRANEL

CESPOL DOBLE PARA FREGADERO - De PP.



CLAVE	MEDIDA	C/M
XK12326G	STD	GRANEL

CESPOL DOBLE PARA FREGADERO - De PP.



CLAVE	MEDIDA	C/M
XK12344	STD	GRANEL

CESPOL DOBLE PARA FREGADERO

- De PP.



CLAVE	MEDIDA	C/M
XK12345	STD	GRANEL

CESPOL FLEXIBLE PARA FREGADERO

- De PVC.
- Extensión XL.

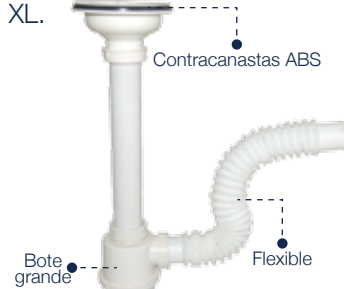

CLAVE	MEDIDA	C/M
XK11501	STD	GRANEL

TRAMPA UNIVERSAL

- De PVC.
- Extensión XL.
- Tubo 25cm

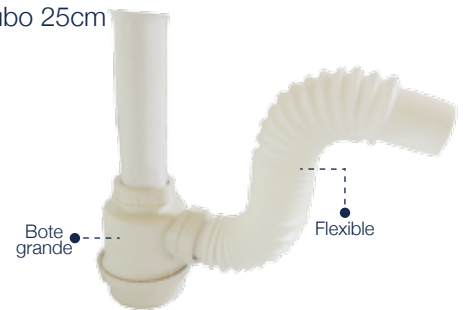

CLAVE	MEDIDA	C/M
XK13284	STD	GRANEL

TRAMPA DOBLE PARA FREGADERO

- De PP.



CLAVE	MEDIDA	C/M
XK12348	STD	1/1

TRAMPA PARA FREGADERO

- Sin contra.



CLAVE	MEDIDA	C/M
XK-10-217C	STD	1/10

TRAMPA PARA FREGADERO

- Sin contra.

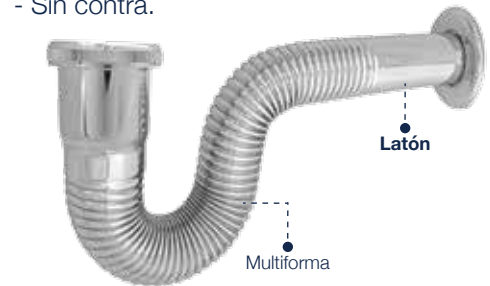

CLAVE	MEDIDA	C/M
XK-10-218	STD	5/50

TRAMPA UNIVERSAL P/ LAVABO Y FREGADERO

- De PP.



CLAVE	MEDIDA	C/M
XK13297GB	STD	GRANEL

TRAMPA UNIVERSAL P/ LAVABO Y FREGADERO

- De PP.

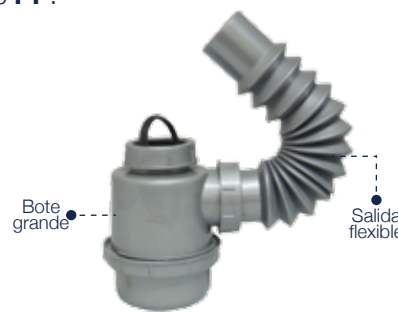

CLAVE	MEDIDA	C/M
XK13297GG	STD	GRANEL

TRAMPA PARA FREGADERO

- De hule.



CLAVE	MEDIDA	C/M
XK13807	STD	GRANEL

CONTRACANASTA PARA FREGADERO

- ABS blanco.
- Sin casquillo.



CLAVE	MEDIDA	C/M
XK1038BP	STD	GRANEL

CONTRACANASTA PARA FREGADERO



CLAVE	MEDIDA	C/M
XK-10-38LZ	STD	GRANEL

CONTRACANASTA PARA FREGADERO



CLAVE	MEDIDA	C/M
XK-10-3811	1/50	STD

CONTRACANASTA PARA FREGADERO

- Cuerpo de PVC.



CLAVE	C/M	MEDIDA
XK-10-3816	5/50	STD

CONTRACANASTA PARA FREGADERO

- Cuerpo ABS.



CLAVE	C/M	MEDIDA
XK-10-3821	1/50	STD

CONTRA REJILLA PARA FREGADERO



ACERO INOXIDABLE

CLAVE	C/M	MEDIDA
XK-10-3831	5/50	2"

CASQUILLOS PARA CONTRA DE FREGADERO

- De aluminio.



CLAVE	C/M	MEDIDA
XCF-10-10	1/1	10 cm
XCF-10-15	1/1	15 cm
XCF-10-20	1/1	20 cm

KIT TARJA 80 SOBREPONER

Incluye:

- XTA-81
- XK-09-318
- XK-13-55
- XK-10-3821
- XK13297GB
- XP-40-13



CLAVE	DESCRIPCIÓN
Z-TA80DR	TARJA DERECHA
Z-TA80IR	TARJA IZQUIERDA

KIT TARJA 80 SOBREPONER

Incluye:

- XTA-81
- XK-09-318
- XK-13-55
- XK-10-3821
- XK13297GB
- P-30-13



CLAVE	DESCRIPCIÓN
Z-TA80DB	TARJA DERECHA
Z-TA80IB	TARJA IZQUIERDA

KIT TARJA 100 SOBREPONER

Incluye:

- XTA-100
- XK-10-318
- XK-13-55
- XK-10-3811
- XK-10-218
- XP-40-13



CLAVE	DESCRIPCIÓN
Z-TA10DR	TARJA DERECHA
Z-TA10IR	TARJA IZQUIERDA

KIT TARJA 100 SOBREPONER

Incluye:

- XTA-100
- XK-10-318
- XK-13-55
- XK-10-3811
- XK-10-218
- XP-40-13



CLAVE	DESCRIPCIÓN
Z-TA10DB	TARJA DERECHA
Z-TA10IB	TARJA IZQUIERDA

KIT LAVABO 1

Incluye:

- XK10235BC
- XP-40-13
- P-30-13
- XK-13-40
- XKZ-13-00



CLAVE	DESCRIPCIÓN
Z-LV-01R	VÁLVULA ANG. ROSCABLE
Z-LV-01B	VÁLVULA ANG. DE BARRIL

KIT LAVABO 2

Incluye:

- XK-10-207
- XP-40-13
- P-30-13
- XK-13-40
- XKZ-13-00



CLAVE	DESCRIPCIÓN
Z-LV-02R	VÁLVULA ANG. ROSCABLE
Z-LV-02B	VÁLVULA ANG. DE BARRIL

KIT WC 1

Incluye:

- Z-87-01
- XP-40-13
- P-30-13
- XK-22-35
- XKZ-13-00



CLAVE	DESCRIPCIÓN
Z-WC-01R	VÁLVULA ANG. ROSCABLE
Z-WC-01B	VÁLVULA ANG. DE BARRIL

KIT WC 2

Incluye:

- XN-09-13
- XP-40-13
- P-30-13
- XK-22-35
- XKZ-13-00



CLAVE	DESCRIPCIÓN
Z-WC-02R	VÁLVULA ANG. ROSCABLE
Z-WC-02B	VÁLVULA ANG. DE BARRIL



BOMBAS

BOMBA PERIFÉRICA

- 120 V / 60 Hz.
- 1" x 1".
- Impulsor de aluminio.
- 3,450 rpm.
- Embobinado de aluminio.

idrop



NOM

CLAVE	C/M	FLUJO	POTENCIA
XKB-10-13R	1/6	32 lt/min	1/2 hp
XKB-10-19R	1/4	32 lt/min	3/4 hp
XKB-10-25R	1/4	32 lt/min	1 hp

BOMBA PERIFÉRICA

- 120 V / 60 Hz.
- 1" x 1".
- Impulsor de aluminio.
- 3,450 rpm.
- Embobinado de aluminio.

idrop



NOM

CLAVE	C/M	FLUJO	POTENCIA
XKB-10-13I	1/6	32 lt/min	1/2 hp

MOTOBOMBA PARA USO AGRÍCOLA

- Motor de cilindro simple.
- 4 tiempos.
- Refrigerado por aire.
- Diámetro x carrera 70x54mm
- Desplazamiento 210m³
- Max. potencia de salida 7.0/3600Hp/rpm
- Capacidad de combustible 3.6 Lts
- Capacidad de aceite 0.6 Lts

alfa NUEVO



CLAVE	C/M	ELEVACIÓN MAX.	SUCCIÓN	FLUJO
XKB-GS-020	1/1	23 metros	7 metros	30m³/h
XKB-GS-030	1/1	31 metros	7 metros	60m³/h

MOTOBOMBA PARA USO AGRÍCOLA

- Motor de cilindro simple.
- 4 tiempos.
- Refrigerado por aire.
- Diámetro x carrera 70x54mm
- Desplazamiento 210m³
- Max. potencia de salida 7.0/3600Hp/rpm
- Capacidad de combustible 3.6 Lts
- Capacidad de aceite 0.6 Lts

alfa NUEVO



CLAVE	C/M	ELEVACIÓN MAX.	SUCCIÓN	FLUJO
XKB-GS-040	1/1	28 metros	7 metros	70m³/h

BOMBA PERIFÉRICA

- 120 V / 60 Hz.
- Impulsor de latón.
- 3,450 rpm.
- Embobinado de cobre.

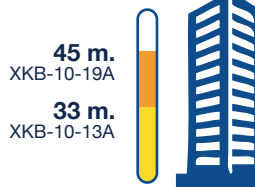

ANCE

CLAVE	C/M	FLUJO	POTENCIA
XKB-10-13A	4/4	32 lt/min	1/2 hp
XKB-10-19A	1/4	50 lt/min	3/4 hp

BOMBA CENTRÍFUGA

- 120 V / 60 Hz.
- Embobinado de cobre.
- 1" x 1".
- Impulsor de latón.
- 3,450 rpm.

30 m.
XKB-CP-25A
28 m.
XKB-CP-19A

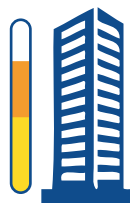

ANCE

CLAVE	C/M	FLUJO	POTENCIA
XKB-CP-19A	1/2	100 lt/min	3/4 hp
XKB-CP-25A	2/2	100 lt/min	1 hp

BOMBA JET

- 120 V / 60 Hz.
- Embobinado de cobre.
- 1" x 1".
- Impulsor de latón.
- 3,450 rpm.

48 m.
XKB-30-25A
44 m.
XKB-30-19A

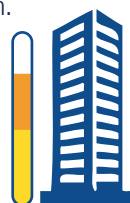

ANCE

CLAVE	C/M	FLUJO	POTENCIA
XKB-30-19A	1/1	45 lt/min	3/4 hp
XKB-30-25A	1/1	60 lt/min	1 hp

BOMBA JET

- 120 V / 60 Hz.
- 1-1/4" x 1".
- Embobinado de cobre.
- Impulsor de latón.
- 3,450 rpm.

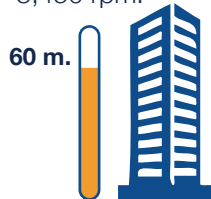

CLAVE	C/M	FLUJO	POTENCIA
XKB-30-38A	1/1	80 lt/min	1.5 hp

BOMBA PRESURIZADORA

- 120 V / 60 Hz.
- 120 W.



CLAVE	C/M	FLUJO	POTENCIA
XKB-10-13C	1/1	30 lt/min	0.16 hp
XKB-10-19C	1/1	50 lt/min	0.36 hp

BOMBA HIDRONEUMÁTICA HORIZONTAL

- Con Jet.
- 120 V / 60 Hz.
- 1" x 1"
- Impulsor de latón.
- 3,450 rpm.

48 m.

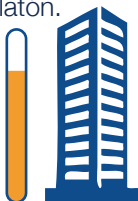

CLAVE	C/M	CAPACIDAD	POTENCIA
XEPJ-25T50	1/1	50 lt/min	1 hp

BOMBA SUMERGIBLE PARA AGUA LIMPIA

- 120 V / 60 Hz.
- Diámetro de salida: 1"

7.5 m.

XKB-20-19A

6 m.

XKB-20-13A

5 m.

XKB-20-33A

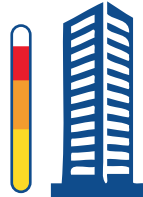

CLAVE	C/M	FLUJO	POTENCIA
XKB-20-33A	1/4	65 lt/min	1/3 hp
XKB-20-13A	1/4	115 lt/min	1/2 hp
XKB-20-19A	1/4	145 lt/min	3/4 hp

BOMBA JET

- 120 V / 60 Hz.
- 1" x 1"
- Embobinado de cobre.
- Impulsor de latón.
- 3,450 rpm.



CLAVE	C/M	POTENCIA
XEPJ-25JST	1/1	1 hp

BOMBA HIDRONEUMÁTICA HORIZONTAL

- Con bomba periférica.
- 120 V / 60Hz.
- Embobinado de cobre.
- 1" x 1".
- Impulsor de latón.
- 3,450 rpm.

33 m.



CLAVE	C/M	CAPACIDAD	POTENCIA
XEPK-13T20	1/1	19 LITROS	1/2 hp
XEPK-13T24	1/1	24 LITROS	1/2 hp

BOMBA HIDRONEUMÁTICA VERTICAL

- 120 V / 60Hz.
- Impulsor de latón.
- 3,450 rpm.
- Flujo: 60 lt/min.

48 m.

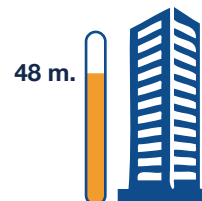

CLAVE	C/M	CAPACIDAD	POTENCIA
XEPJ-25T80	1/1	80 LITROS	1 hp
XEPJ-25T00	1/1	100 LITROS	1 hp
XEPJ-25T05	1/1	150 LITROS	1 hp

BOMBA SUMERGIBLE PARA AGUA RESIDUAL

- 120 V / 60Hz.
- Diámetro de salida: 1"

5.5 m.

XKB-21-19A

4.5 m.

XKB-21-13A

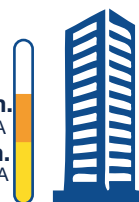

CLAVE	C/M	FLUJO	POTENCIA
XKB-21-13A	1/4	110 lt/min	1/2 hp
XKB-21-19A	1/4	130 lt/min	3/4 hp

TANQUE VERTICAL

- Presión de trabajo: 2 bar.
- Diámetro de salida: 3/4"
- Espesor del material: 0.8mm.



CLAVE	C/M	CAPACIDAD	ALTURA
XKB-11-80	1/1	80 litros	720 mm
XKB-11-100	1/1	100 litros	770 mm
XKB-11-150	1/1	150 litros	920 mm

TANQUE HORIZONTAL

- Presión de trabajo: 2 bar.
- Diámetro de salida: 3/4"
- Espesor del material: 0.8mm.



CLAVE	C/M	CAPACIDAD	ALTURA
XKB-11-24	1/1	24 litros	290 mm
XKB-11-50	1/1	50 litros	350 mm

ELECTRONIVEL

- De 20 Amps.
- Hasta 3 mts. de profundidad.
- Flotador eléctrico.



CLAVE	C/M	MEDIDA
XKB-SMAL-3	1/1	3 mts

AUTOMÁTICO



CLAVE	C/M
XKB-SW-13	1/16

FLOTADOR PARA W.C.

- De poliuretano.
- Con varilla tropicalizada.



CLAVE	C/M	MEDIDA
XPN-10-004	GRANEL	No. 4
XPN-10-005	GRANEL	No. 5
XPN-10-006	GRANEL	No. 6

VÁLVULA DE TANQUE ALTO

- En latón.
- Para cisterna.
- Con flotador de poliuretano.
- Incluye flotador.



CLAVE	C/M	MEDIDA
XNL-05-19	12/96	3/4"
XNL-05-25	8/96	1"
XNL-05-32	2/36	1-1/4"
XNL-05-38	2/36	1-1/2"

FLOTADOR PARA TINACO

- De polipropileno.
- Para tanque alto.
- Con varilla tropicalizada.



CLAVE	C/M	MEDIDA
XN-05-13	GRANEL	No. 5

VÁLVULA PARA TINACO

- De polietileno.
- Rosca exterior 3/4".
- Rosca interior 1".



CLAVE	C/M	MEDIDA
X626032	1/40	3/4" - 1"

VÁLVULA DE TANQUE ALTO

- De latón.
- Sin flotador.



CLAVE	C/M	MEDIDA
XNL-04-13	10/200	1/2"
XNL-04-19	10/200	3/4"

VÁLVULA DE TANQUE ALTO

- En Bronce.
- Reforzada.
- Sin flotador.



CLAVE	C/M	MEDIDA
N-04-13	12/120	1/2"
N-04-19	8/80	3/4"

MULTIREDUCTOR

- De latón.
- Con jarro de aire.
- Para tinaco.
- Forjado y cobrizado.



CLAVE	C/M	MEDIDA
MF-04-3219	6/60	1-1/4"-3/4"

VÁLVULA DE RETENCIÓN

- De latón.
- Con filtro de acero inoxidable.
- 100 Micron.



CLAVE	C/M	MEDIDA
XP-20-25	10/100	1"
XP-20-32	5/50	1-1/4"

VÁLVULA REDUCTORA

- Regula el flujo de agua que entra al domicilio.
- Disminuye el caudal.
- Reduce la presión.

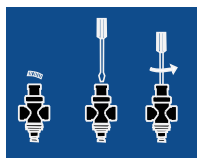

CLAVE	C/M	MEDIDA
XK-VR-13	1/1	1/2"

PRESOSTATO

- Rango de presión: 26-43.5 PSI
- Diámetro de salida: 1/4"
- Regulación: 1.4 bar - 2.8 bar.



CLAVE	C/M	MEDIDA
XKB-FSG/2	1/50	1/4"

VÁLVULA

- De 5 vías.
- Para hidroneumático.



CLAVE	C/M	MEDIDA
XKB-R/5	10/100	1"

VÁLVULA CHECK

- Hidráulica.
- Polipropileno.



CLAVE	C/M	DETALLES	MEDIDA
XPRE-38-19	1/1	P/ TINACO	1-1/2"

VÁLVULA DE RETENCIÓN

- De latón.



CLAVE	C/M	MEDIDA
XP-19-13	1/1	1/2"
XP-19-19	1/1	3/4"
XP-19-25	1/1	1"
XP-19-32	1/1	1-1/4"

MANOMETRO

- Para hidroneumático.



CLAVE	C/M	MEDIDA
XKB-MR/6	10/100	STD

PICHANCHA

- De latón.
- Con rejilla abierta.

CLAVE	C/M	MEDIDA
P-10-13	15/225	1/2"
P-10-19	15/150	3/4"
P-10-25	10/100	1"
P-10-32	8/80	1-1/4"
P-10-38	6/48	1-1/2"
P-10-51	4/32	2"
P-10-76	2/12	3"
P-10-102	1/4	4"



VÁLVULA CHECK

- Hidráulica.
- Polipropileno.



CLAVE	C/M	DETALLES	MEDIDA
D-60-13	1/1	P/ TOMA DOM.	1/2"

VÁLVULA CHECK COLUMPIO

- De latón.
- 200 lb. WOG



CLAVE	C/M	MEDIDA
XBV-10-13	5/150	1/2"
XBV-10-19L	10/80	3/4"
XBV-10-19	10/80	3/4"
XBV-10-25	4/40	1"

MANGUERA

- Para hidroneumático.



CLAVE	C/M	MEDIDA
XKB-TF/6	1/75	1"

VÁLVULA CHECK

- PVC.



CLAVE	C/M	MEDIDA
XP4-20-13	10/100	1/2"

MULTICONECTOR PLÁSTICO

- Con salida para jarro de aire.
- Entrada 1 1/2" rosca exterior.
- Salida 3/4" rosca exterior.



CLAVE	C/M	MEDIDA
X-70538-19	GRANEL	1-1/2"

MULTICONECTOR PLÁSTICO

- Con salida para jarro de aire.
- Tuerca con rosca interior.
- 3/4"

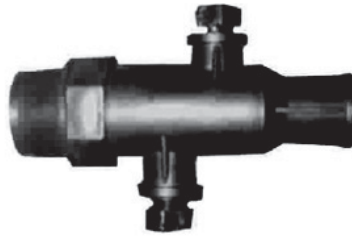

CLAVE	C/M	MEDIDA
X-70539-19	1/1	1-1/2"



LLAVE DE MANGUERA

- De ABS.
- De esfera.



CLAVE	C/M	MEDIDA
XSG-40-13P	18/180	1/2"

LLAVE DE MANGUERA

- De Zinc.
- Con rosca en la nariz.

ídrop



CLAVE	C/M	MEDIDA
XSG-42-13	18/180	1/2"

LLAVE DE MANGUERA

- De latón.
- Sin pulir.
- Con rosca en la nariz.
- Peso: 110 g.



CLAVE	C/M	MEDIDA
XSG-44-13	12/120	1/2"

LLAVE DE MANGUERA

- De latón.
- Sin pulir.
- Con rosca en la nariz.
- Peso: 140 g.



CLAVE	C/M	MEDIDA
XSG-40-13	12/120	1/2"

LLAVE DE MANGUERA

- De latón.
- Acabado cromo.



CLAVE	C/M	MEDIDA
XKG-51-13	10/120	1/2"

LLAVE DE MANGUERA

- De bronce.
- Sin pulir.
- Con rosca en la nariz.
- Peso: 161 g.



ALTA DURACIÓN

CLAVE	C/M	MEDIDA
G-40-13	12/120	1/2"

LLAVE DE MANGUERA

- De bronce.
- Sin pulir.
- Peso: 145 g.



ALTA DURACIÓN

CLAVE	C/M	MEDIDA
G-50-13	12/120	1/2"

LLAVE DE MANGUERA

- De bronce.
- Reforzada.
- Sin pulir.
- Con rosca en la nariz.
- Peso: 181 g.



ALTA DURACIÓN

CLAVE	C/M	MEDIDA
G-45-13	12/120	13 mm

LLAVE DE MANGUERA

- De latón.
- Tipo esfera.
- Con conexión estriada.



CLAVE	C/M	MEDIDA
XBG-40-13	12/120	1/2"

LLAVE DE MANGUERA

- De **zinc**.
- Tipo esfera.
- Con conexión estriada.



CLAVE	C/M	MEDIDA
XBG-42-13	12/96	1/2"

LLAVE DE MANGUERA

- De **latón**.
- Tipo esfera.
- Con candado.



CLAVE	C/M	MEDIDA
XBG-40-13C	12/120	1/2"

RESORTE PARA LLAVE DE JARDÍN



CLAVE	C/M	MEDIDA
XK-19-16	5/200	1/2"

PISTOLA PARA RIEGO

- Con palanca.
- Con 5 funciones para riego.



CLAVE	C/M	COLOR
JA-001	1/1	Verde

PISTOLA PARA RIEGO

- Con mango.
- Con 8 funciones para riego.



CLAVE	C/M	COLOR
JA-002	1/1	Amarillo

MANGUERA PARA JARDÍN

- Uso ligero.
- De 2 capas.
- Conexiones plásticas.



PROX.
MAY

CLAVE	MEDIDA	LARGO
XSG-2P-10	1/2"	10 m
XSG-2P-15	1/2"	15 m
XSG-2P-20	1/2"	20 m
XSG-2P-25	1/2"	25 m

MANGUERA PARA JARDÍN

- Uso ligero.
- De 3 capas.
- Conexiones plásticas.



CLAVE	MEDIDA	LARGO
XSG-3P-10	1/2"	10 m
XSG-3P-15	1/2"	15 m
XSG-3P-20	1/2"	20 m
XSG-3P-25	1/2"	25 m

MANGUERA PARA JARDÍN

- Uso doméstico.
- Reforzada.
- De 3 capas.
- Conexiones de aluminio.



CLAVE	MEDIDA	LARGO
XSG-3L-10	1/2"	10 m
XSG-3L-15	1/2"	15 m
XSG-3L-20	1/2"	20 m
XSG-3L-25	1/2"	25 m
XSG-3L5-20	5/8"	20 m
XSG-3L5-25	5/8"	25 m
XSG-3L5-30	5/8"	30 m

MANGUERA EN ROLLO PARA JARDÍN

- Uso doméstico.
- Reforzada.
- De 3 capas.



CLAVE	MEDIDA	KG	LARGO
XSG-3-100	1/2"	10kg	100 m
XSG-35-100	5/8"	16kg	100 m
XSG-33-100	3/4"	23kg	100 m
XSG-31-100	1"	40kg	50 m

MANGUERA EN ROLLO DE NIVEL

- Transparente.



CLAVE	MEDIDA	PESO X M	LARGO
XMN-06-100	1/4"	20g	100 m
XMN-08-100	5/16"	38g	100 m
XMN-10-100	3/8"	45g	100 m
XMN-13-100	1/2"	65g	100 m



MANGUERA EN ROLLO INDUSTRIAL

- Transparente.



CLAVE	MEDIDA	PESO X M	LARGO
XMI-04-100	3/16"	20g	100 m
XMI-06-100	1/4"	29g	100 m
XMI-08-100	5/16"	44g	100 m
XMI-10-100	3/8"	71g	100 m
XMI-13-100	1/2"	92g	100 m
XMI-15-100	5/8"	144g	100 m
XMI-19-100	3/4"	169g	100 m
XMI-25-100	1"	374g	100 m



CONECTOR

- Para manguera tramada.
- Latón laminado.



CLAVE	C/M	MEDIDA
XSG-40-CO	25/400	1/2"

CONECTOR

- Para manguera tramada.
- Latón laminado.



CLAVE	C/M	MEDIDA
XSG-40-COH	20/400	1/2"

ADAPTADOR YUCATÁN CORTO

- De **latón**.
- Entrada: rosca NPT.
- Salida: tubo de polietileno.
- Unión estriada.



CLAVE	C/M	MEDIDA
XKA-11-13	25/500	1/2"
XKA-11-19	25/500	3/4"
XKA-11-25	10/220	1"

ADAPTADOR HEMBRA

- De **bronce**.
- Entrada rosca NPT.
- Salida: poliducto.
- Unión estriada.



ALTA DURACIÓN		
CLAVE	C/M	MEDIDA
A-30-13	30/300	1/2"
A-30-19	15/150	3/4"

ADAPTADOR MACHO LARGO

- De **bronce**.
- Entrada: rosca NPT/ rosca AWWA.
- Salida: tubo de polietileno tipo RD9.
- Unión estriada.



ALTA DURACIÓN

CLAVE	C/M	MEDIDA
A-10-13	25/250	1/2"
A-10-19	15/150	3/4"
A-10-25	10/100	1"

CONECTOR HEMBRA

- Para manguera.
- De plástico.



CLAVE	C/M	MEDIDA
XSG-40-HCO	25/500	1/2"

CONECTOR MACHO

- Para manguera.
- De plástico.



CLAVE	C/M	MEDIDA
XSG-40-MCO	25/500	1/2"



CINTA DE AISLAR

- Flexible para cubrir superficies irregulares.
- Espesor: 0.13 mm.
- Elongación: 200 %



CLAVE	C/M	MEDIDA
XK-AS-0919	10/500	9 X 19 mm
XK-AS-1819	10/200	18 X 19 mm

CINTA CANELA

- Ideales para polietilenos
- Ancho: 48 mm
- Espesor: 0.050 mm



*Adhesivo acrílico base agua de adherencia media que conserva sus propiedades por largos periodos.

CLAVE	C/M	LONGITUD
XK-CN-4048	6/72	40 m
XK-CN-5048	6/72	50 m
XK-CN15048	6/36	150 m

CINTA TRANSPARENTE

- Ideales para polietilenos
- Ancho: 48 mm
- Espesor: 0.050 mm



*Adhesivo acrílico base agua de adherencia media que conserva sus propiedades por largos periodos.

CLAVE	C/M	LONGITUD
XK-DX-4048	8/72	40 m
XK-DX-5048	8/72	50 m
XK-DX15048	6/36	150 m

CINTA PARA DUCTOS RESISTENTE A ALTAS TEMPERATURAS

- Usos generales
- Ancho: 48 mm
- Espesor: 0.050 mm
- Elongación mín.: 10%
- Temp. máx.: 60 °C



*Cinta de polietileno reforzada con malla de algodón

CLAVE	C/M	LONGITUD
XK-DC-1048	6/72	10 m
XK-DC-3048	6/48	30 m
XK-DC-5048	6/24	50 m

CINTA MASKING TAPE

- Adherencia media
- Para uso general
- Espesor: 0.13 mm



*Adhesivo de hule-resina
*Papel de alta resistencia

CLAVE	C/M	LONGITUD
XK-MK-5013	12/144	12 mm
XK-MK-5019	8/96	18 mm
XK-MK-5025	8/72	24 mm
XK-MK-5038	8/48	36 mm
XK-MK-5051	8/36	48 mm

CINTA DE SEÑALIZACIÓN

- Ancho: 48 mm
- Espesor: 0.106 mm



*Adhesivo acrílico base solvente

CLAVE	C/M	LONGITUD
XK-CPM1840	10/60	18m

DESPACHADOR DE CINTA

- Incluye dos rollos de cinta transparente con adhesivo acrílico de 50 m.



*Maneja cintas de 48 mm de ancho y 77 mm de diámetro interno

CLAVE	C/M	MEDIDA
XK-DX-DESP	1/18	23.3X14.1X7cm

CINTA DE MONTAJE

- Se adhiere permanentemente a la mayoría de las superficies
- Ancho: 19 mm
- Soporta hasta: 900 g.



*Cinta de espuma con doble adhesivo

CLAVE	C/M	LONGITUD
XK-DL-0219	4/60	2.28 m
XK-DL-0519	10/80	5 m

CINTA SELLA ROSCAS

- De 0.1 mm de grosor.
- Densidad: 0.3g/cm³



CLAVE	C/M	MEDIDA
XKZA-13-26	100/1000	1/2"x260"
XKZA-13-52	100/1000	1/2"x520"
XKZA-19-26	100/1000	3/4"x260"
XKZA-19-52	100/1000	3/4"x520"

CINTA

- Antiderrapante.
- De seguridad.
- Rollo de 9.15 mts.



CLAVE	C/M	MEDIDA
XCA-25-10	1/12	1"



LONAS

LONA ROJA

- 90 g/m²
- Espesor: 0.12mm
- Termosellada
- Cuerda PP en dobladillo.
- Refuerzo de rafia en la orilla.



CLAVE	C/M	MEDIDA
LN-RJ0923	20/20	2 x 3 m
LN-RJ0933	14/14	3 x 3 m
LN-RJ0934	10/10	3 x 4 m
LN-RJ0945	6/6	4 x 5 m
LN-RJ0946	4/4	4 x 6 m
LN-RJ0956	5/5	5 x 6 m
LN-RJ09612	2/2	6 x 12 m

LONA AZUL

- 90 g/m²
- Espesor: 0.12mm
- Termosellada
- Cuerda PP en dobladillo.
- Refuerzo de rafia en la orilla.



CLAVE	C/M	MEDIDA
LN-AZ0923	20/20	2 x 3 m
LN-AZ0933	10/10	3 x 3 m
LN-AZ0934	10/10	3 x 4 m
LN-AZ0945	6/6	4 x 5 m
LN-AZ0946	5/5	4 x 6 m
LN-AZ0956	5/5	5 x 6 m
LN-AZ09612	2/2	6 x 12 m

LONA AZUL

- 110 g/m²
- Espesor: 0.14mm
- Hilos por pulgada: 10x10
- Termosellada.



*Con esquinero de polietileno

CLAVE	C/M	MEDIDA
LN-AZ1123	15/15	2 x 3 m
LN-AZ1133	8/8	3 x 3 m
LN-AZ1134	8/8	3 x 4 m
LN-AZ1145	5/5	4 x 5 m
LN-AZ1146	5/5	4 x 6 m
LN-AZ1156	5/5	5 x 6 m
LN-AZ11612	2/2	6 x 12 m

LONA ROJA

- 110 g/m²
- Espesor: 0.14mm
- Hilos por pulgada: 10x10
- Termosellada.



*Con esquinero de polietileno

CLAVE	C/M	MEDIDA
LN-RJ1123	20/20	2 x 3 m
LN-RJ1133	10/10	3 x 3 m
LN-RJ1134	10/10	3 x 4 m
LN-RJ1145	5/5	4 x 5 m
LN-RJ1146	5/5	4 x 6 m
LN-RJ1156	5/5	5 x 6 m
LN-RJ11612	2/2	6 x 12 m

LONA REFORZADA GRIS

- 180 g/m²
- Espesor: 0.25mm
- Hilos por pulgada: 14x14
- Termosellada.



*Refuerzo de rafia en toda la orilla
*Con esquinero de polietileno

CLAVE	C/M	MEDIDA
LN-GN1823	10/10	2 x 3 m
LN-GN1833	10/10	3 x 3 m
LN-GN1834	5/5	3 x 4 m
LN-GN1845	3/3	4 x 5 m
LN-GN1846	3/3	4 x 6 m
LN-GN1856	2/2	5 x 6 m
LN-GN18612	1/1	6 x 12 m

LONA REFORZADA AZUL

- 180 g/m²
- Espesor: 0.25mm
- Hilos por pulgada: 14 x 14
- Termosellada.



*Refuerzo de rafia en toda la orilla
*Con esquinero de polietileno

CLAVE	C/M	MEDIDA
LN-AN1823	10/10	2 x 3 m
LN-AN1833	10/10	3 x 3 m
LN-AN1834	5/5	3 x 4 m
LN-AN1845	5/5	4 x 5 m
LN-AN1846	3/3	4 x 6 m
LN-AN1856	2/2	5 x 6 m
LN-AN18612	1/1	6 x 12 m



V
Á
L
V
U
L
A
S

VÁLVULA DE GLOBO

- De **bronce**.
- Reforzada.
- Rosca hembra NPT.
- 100 lbs. WOG.
- Peso: 240 g.



CLAVE	C/M	MEDIDA
GR-10-13	12/120	1/2"

VÁLVULA DE GLOBO

- De **bronce**.
- Rosca hembra NPT.
- 100 lbs. WOG.
- Peso 1/2": 156 g.
- Peso 3/4": 208 g.



CLAVE	C/M	MEDIDA
G-10-13	12/120	1/2"
G-10-19	10/100	3/4"

VÁLVULA DE GLOBO

- De **bronce**.
- Ligera.
- Rosca hembra NPT.
- 100 lbs. WOG.
- Peso: 140 g.



CLAVE	C/M	MEDIDA
GL-10-13	12/120	1/2"

VÁLVULA DE GLOBO

- De **latón**.
- Ligera.
- Rosca hembra NPT.
- 100 lbs. WOG.



CLAVE	C/M	MEDIDA
XGL-10-13	12/120	1/2"
XGL-10-19	10/100	3/4"
XGL-10-25	1/1	1"

VÁLVULA DE GLOBO

- De **bronce**.
- Soldable.
- 100 lbs. WOG.
- Peso 1/2"=146 g.
- Peso 3/4"=216 g.



CLAVE	C/M	MEDIDA
G-20-13	12/120	1/2"
G-20-19	5/50	3/4"

VÁLVULA DE GLOBO

- De **bronce**.
- Ligera.
- Soldable.
- 100 lbs. WOG.
- Peso: 117 g.



CLAVE	C/M	MEDIDA
GL-20-13	15/150	1/2"

VÁLVULA DE GLOBO

- De **latón**.
- Soldable.
- 100 lbs. WOG.



CLAVE	C/M	MEDIDA
XGL-20-13	20/120	1/2"
XGL-20-19	20/120	3/4"
XGL-20-25	1/1	1"

VÁLVULA DE GLOBO

- De **bronce**.
- Ligera.
- Rosca hembra NPT.
- 100 lbs. WOG.
- 138 g.
- Con cacahuete



CLAVE	C/M	MEDIDA
GL-12-13	12/120	1/2"

VÁLVULA DE GLOBO

- De **bronce**.
- Angular.
- Rosca hembra NPT.
- 100 lbs. WOG.
- Peso: 166 g.



CLAVE	C/M	MEDIDA
G-30-13	10/100	1/2"

VÁLVULA ANGEL

- De **latón**.
- Para gas.



CLAVE	C/M	MEDIDA
XGA-13-19	10/100	1/2" x 3/4"



VÁLVULA DE ESFERA

- De **latón**.
- Con tuerca loca.
- Para gas.



CLAVE	C/M	MEDIDA
XSB-47-13	12/108	1/2"

VÁLVULA DE ESFERA

- De **latón**.
- Rosca hembra NPT.
- Uso: para gas.
- 200 lb. WOG



CLAVE	C/M	MEDIDA
XSB-40-13	14/126	1/2"
XSB-40-19	8/72	3/4"
XSB-40-25	4/36	1"
XSB-40-51	1/10	2"

VÁLVULA DE ESFERA

- De **latón forjado**.
- Rosca hembra NPT.
- Cierre de 90°
- Paso completo.
- Con asiento de teflón.
- 300 lb. WOG



producto MEJORADO

CLAVE	C/M	MEDIDA
XSB-08-13	1/81	1/2"
XSB-08-19	12/96	3/4"
XSB-08-25	9/81	1"

VÁLVULA DE ESFERA

- De **latón**.
- Soldable.
- Cierre de 90°
- Paso completo
- Con asiento de teflón.
- 300 lb. WOG



producto MEJORADO

CLAVE	C/M	MEDIDA
XSB-18-13	16/144	1/2"
XSB-18-19	9/81	3/4"
XSB-18-25	4/36	1"

VÁLVULA DE ESFERA

- De **latón**.
- Rosca NPT.
- Cierre de 90°
- Paso reducido.
- Con asiento de teflón.
- 300 lb. WOG



CLAVE	C/M	MEDIDA
XSB-09-13	20/180	1/2"
XSB-09-19	14/126	3/4"
XSB-09-25	8/64	1"
XSB-09-32	4/36	1-1/4"
XSB-09-38	4/32	1-1/2"
XSB-09-51	2/18	2"
XSB-09-63	1/1	2-1/2"
XSB-09-76	1/6	3"
XSB-09-102	1/1	4"

VÁLVULA DE ESFERA

- De **latón**.
- Soldable.
- Cierre de 90°
- Paso reducido.
- Con asiento de teflón.
- 300 lb. WOG



CLAVE	C/M	MEDIDA
XSB-19-13	24/192	1/2"
XSB-19-19	16/128	3/4"
XSB-19-25	9/81	1"
XSB-19-32	6/48	1-1/4"
XSB-19-38	4/32	1-1/2"
XSB-19-51	2/14	2"

VÁLVULA DE ESFERA

- De **latón**.
- Rosca NPT x SOLDABLE
- Cierre de 90°.
- Paso completo.
- Con asiento de teflón.
- 300 lb. WOG



CLAVE	C/M	MEDIDA
XSB-70-19	14/140	3/4"

VÁLVULA DE ESFERA

- De **latón**.
- Rosca NPT.
- Paso reducido.
- Sistema LOCK.
- Para GAS.
- 300 lb. WOG



SISTEMA LOCK PATENTADO

CLAVE	C/M	MEDIDA
XSB-60-13	16/144	1/2"
XSB-60-19	12/108	3/4"
XSB-60-25	9/81	1"



VÁLVULA DE ESFERA

- De **latón**.
- Rosca NPT.
- Paso reducido.
- Sistema LOCK.
- Para AGUA.
- 300 lb. WOG



SISTEMA LOCK PATENTADO

CLAVE	C/M	MEDIDA
XSB-61-13	16/144	1/2"
XSB-61-19	12/108	3/4"



VÁLVULA DE COMPUERTA

- De **latón**.
- Rosca NPT.
- 200 lb. WOG

CLAVE	C/M	MEDIDA
J-10-13	10/100	1/2"
J-10-19	10/100	3/4"
J-10-25	6/60	1"
J-10-32	5/50	1-1/4"
J-10-38	2/40	1-1/2"
J-10-51	2/10	2"
J-10-63	1/8	2-1/2"
J-10-76	1/8	3"
J-10-102	1/4	4"



VÁLVULA DE COMPUERTA

- De **latón**.
- Soldable.
- 200 lb. WOG

CLAVE	C/M	MEDIDA
J-20-13	12/120	1/2"
J-20-19	10/100	3/4"
J-20-25	6/60	1"
J-20-32	5/50	1-1/4"
J-20-38	2/30	1-1/2"
J-20-51	2/16	2"
J-20-76	1/6	3"





C O B R E

CODO REDUCIDO

- De 90°



CLAVE	C/M	MEDIDA
XSC-19-13	50/500	3/4"x1/2"

CODO

- De 90°



CLAVE	C/M	MEDIDA
XSC-10-09	100/1000	3/8"
XSC-10-13L	50/1300	1/2"
XSC-10-19	20/400	3/4"
XSC-10-25	20/200	1"
XSC-10-32	5/120	1-1/4"
XSC-10-38	5/80	1-1/2"
XSC-10-51	2/40	2"

CODO

- De 90°.
- EPC.
- Reforzado.



CLAVE	C/M	MEDIDA
XSC-10-13	100/1000	1/2"

CODO

- De 45°



CLAVE	C/M	MEDIDA
XSC-11-13	50/1300	1/2"
XSC-11-19	20/400	3/4"
XSC-11-25	20/240	1"
XSC-11-32	5/140	1-1/4"
XSC-11-38	2/90	1-1/2"
XSC-11-51	2/50	2"

CODO

- De 90°
- Con rosca interior.



CLAVE	C/M	MEDIDA
XSC-20-13	20/600	1/2"
XSC-20-19	10/250	3/4"
XSC-20-25	20/20	1"

CODO

- De 90°
- Con rosca exterior.



CLAVE	C/M	MEDIDA
XSC-30-13	20/20	1/2"
XSC-30-19	10/10	3/4"

COPLE



CLAVE	C/M	MEDIDA
XSP-10-13	100/1000	1/2"
XSP-10-19	100/800	3/4"
XSP-10-25	50/500	1"
XSP-10-32	20/200	1-1/4"
XSP-10-38	20/200	1-1/2"
XSP-10-51	5/50	2"

REDUCCIÓN CAMPANA



CLAVE	C/M	MEDIDA
XSR-13-10A	100/1000	1/2"x3/8"
XSR-19-13A	100/1000	3/4"x1/2"
XSR-25-13A	50/500	1"x1/2"
XSR-25-19A	50/500	1"x3/4"
XSR-32-13A	25/250	1-1/4"x1/2"
XSR-32-19A	25/250	1-1/4"x3/4"
XSR-32-25A	25/250	1-1/4"x1"
XSR-38-13A	5/50	1-1/2"x1/2"
XSR-38-19A	5/50	1-1/2"x3/4"
XSR-38-25A	5/50	1-1/2"x1"
XSR-38-32A	5/50	1-1/2"x1-1/4"



REDUCCIÓN BUSHING

CLAVE	C/M	MEDIDA
XSR-13-10	100/1000	1/2"x3/8"
XSR-19-13	100/1000	3/4"x1/2"
XSR-25-13	50/500	1"x1/2"
XSR-25-19	50/500	1"x3/4"
XSR-32-13	25/250	1-1/4"x1/2"
XSR-32-19	25/250	1-1/4"x3/4"
XSR-32-25	25/250	1-1/4"x1"
XSR-38-13	5/50	1-1/2"x1/2"
XSR-38-19	5/50	1-1/2"x3/4"
XSR-38-25	5/50	1-1/2"x1"
XSR-38-32	5/50	1-1/2"x1-1/4"

CONECTOR

- Con rosca exterior.



CLAVE	C/M	MEDIDA
XSI-10-13	50/100	1/2"
XSI-10-19	30/420	3/4"
XSI-10-25	20/280	1"
XSI-10-32	9/144	1-1/4"
XSI-10-38	8/112	1-1/2"
XSI-10-51	4/64	2"

CONECTOR

- Con rosca interior.



CLAVE	C/M	MEDIDA
XSI-11-13	50/900	1/2"
XSI-11-19	30/420	3/4"
XSI-11-25	15/210	1"
XSI-11-32	8/128	1-1/4"
XSI-11-38	6/84	1-1/2"
XSI-11-51	2/60	2"

TUERCA UNIÓN

- Soldable.



CLAVE	C/M	MEDIDA
T-11-13	20/360	1/2"
T-11-19	10/280	3/4"
T-11-25	5/120	1"
T-11-32	5/70	1-1/4"
T-11-38	3/60	1-1/2"
T-11-51	2/40	2"

TUERCA UNIÓN

- Roscable.



CLAVE	C/M	MEDIDA
XLT-12-13	10/400	1/2"
XLT-12-19	10/200	3/4"
XLT-12-25	8/80	1"

TEE



CLAVE	C/M	MEDIDA
D-711-13	50/700	1/2"
D-711-19	20/240	3/4"
D-711-25	10/120	1"
D-711-32	4/80	1-1/4"
D-711-38	2/50	1-1/2"
D-711-51	1/25	2"

TEE

- De **bronce**.
- Con rosca al centro
- Extremos soldables.



CLAVE	C/M	MEDIDA
D-712-13	25/250	1/2"

TEE REDUCIDA



CLAVE	C/M	MEDIDA
XSE-13-13	25/250	1/2X1/2X3/4
XSE-19-19	10/300	3/4X3/4X1/2
XSE-19-13	10/120	3/4X1/2X3/4
XSE-22-13	0/0	3/4X1/2X1/2

YEE

- Soldable.



CLAVE	C/M	MEDIDA
XY-700-13	10/100	1/2"
XY-700-19	1/80	3/4"
XY-700-25	1/50	1"

TAPÓN CAPA



CLAVE	C/M	MEDIDA
XSA-10-13	100/1000	1/2"
XSA-10-19	100/800	3/4"
XSA-10-25	50/500	1"
XSA-10-32	20/200	1-1/4"
XSA-10-38	20/200	1-1/2"
XSA-10-51	5/50	2"

REDUCCIÓN

- De **Cobre**.
- Rosca exterior.



CLAVE	C/M	S/NPT
XSI-101319	30/480	1/2"x3/4"
XSI-101913	20/600	3/4"x1/2"
XSI-101925	20/320	3/4"x1"

REDUCCIÓN

- De **Cobre**.
- Rosca interior.



CLAVE	C/M	S/NPT
XSI-111319	20/600	1/2"x3/4"
XSI-111913	20/600	3/4"x1/2"
XSI-111925	10/300	3/4"x1"

SOLDADURA

- Para plomería.



producto MEJORADO

CLAVE	C/M	MEDIDA
XSZ-50-450	1/50	1/2"x1/2"
XSZ-50-50	1/50	50 x 50
XSZ-95-0.5	1/50	95 x 0.5

PASTA PARA SOLDAR



CLAVE	C/M	DETALLES	MEDIDA
XS-01	5/45	CON LIJA	60 g
XS-02	5/45	CON LIJA	100 g
XS-03	1/45	CON LIJA	300 g
XS-06	5/45	SIN LIJAR	60 ml
XS-04	5/45	SIN LIJAR	100 ml
XS-05	5/45	SIN LIJAR	300 ml

USO INDUSTRIAL RESIDENCIAL
TIPO COMPRESIÓN

COBRE

CORTE, AJUSTE Y LISTO
LAS CONEXIONES ALFA-EASY
LE AYUDAN A CONECTAR:
COBRE, PE-AL-PE, CPVC Y PEX

PE-AL-PE

PVC

CODO

- De 90°.
- De Cobre.



CLAVE	C/M	MEDIDA
XSCR-1013C	1/1	1/2"
XSCR-1019C	1/1	3/4"

CODO CON OREJA

- De 90°.
- De Cobre.



CLAVE	C/M	MEDIDA
XSCR-1213C	1/1	1/2"

CONECTOR MACHO

- De Cobre.
- Rosca exterior.



CLAVE	C/M	MEDIDA
XSIR-1013C	1/1	1/2"
XSIR-1019C	1/1	3/4"

CONECTOR HEMBRA

- De Cobre.
- Rosca interior.



CLAVE	C/M	MEDIDA
XSIR-2013C	1/1	1/2"
XSIR-2019C	1/1	3/4"

TEE

- De Cobre.



CLAVE	C/M	MEDIDA
DR-711-13C	1/1	1/2"
DR-711-19C	1/1	3/4"

TAPÓN

- De Cobre.



CLAVE	C/M	MEDIDA
XSAR-1013C	1/1	1/2"
XSAR-1019C	1/1	3/4"

HERRAMIENTA

- Para instalación.
- Para conexiones de Cobre.



CLAVE	C/M	MEDIDA
XKR-10-13C	1/1	1/2"
XKR-10-19C	1/1	3/4"

CORTE, AJUSTE Y LISTO

LAS CONEXIONES **ALFA-EASY** LE AYUDAN A CONECTAR:
COBRE, PE-AL-PE, CPVC Y PEX

CONEXIONES REUTILIZABLES EN CUALQUIER TIPO DE COMBINACIÓN.



MARQUE EL TUBO EN LA PROFUNDIDAD DEMOSTRADA

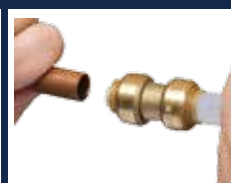

INSERTE EL TUBO



GIRE EL TUBO MIENTRAS LO INSERTA EN LA CONEXIÓN HASTA LA MARCA



NO REQUIERE SOLDADURA



USO INDUSTRIAL RESIDENCIAL



TIPO COMPRESIÓN



MATERIAL LATÓN

CODO

- De 90°.
- De Latón.



CLAVE	C/M	MEDIDA
XSCR-10-13	1/1	1/2"
XSCR-10-19	1/1	3/4"

CODO HEMBRA

- De 90°.
- De Latón.



CLAVE	C/M	MEDIDA
XSCR-20-10	1/1	3/8"
XSCR-20-13	1/1	1/2"
XSCR-20-19	1/1	3/4"

CODO CON OREJA

- De 90°.
- De Latón.



CLAVE	C/M	MEDIDA
XSCR-12-13	1/1	1/2"
XSCR-12-19	1/1	3/4"

CONECTOR MACHO

- De Latón.
- Rosca exterior.



CLAVE	C/M	MEDIDA
XSIR-10-13	1/1	1/2"
XSIR-10-19	1/1	3/4"

CONECTOR HEMBRA

- De Latón.
- Rosca interior.



CLAVE	C/M	MEDIDA
XSIR-20-13	1/1	1/2"
XSIR-20-19	1/1	3/4"

TEE

- De Latón.



CLAVE	C/M	MEDIDA
DR-711-13	1/1	1/2"
DR-711-19	1/1	3/4"

TEE HEMBRA

- De Latón.
- Rosca interior.



CLAVE	C/M	MEDIDA
DR-712-13	1/1	1/2"
DR-712-19	1/1	3/4"

TAPÓN

- De Latón.



CLAVE	C/M	MEDIDA
XSAR-10-13	1/1	1/2"
XSAR-10-19	1/1	3/4"

HERRAMIENTA

- Para instalación.
- Para conexiones de Latón.



CLAVE	C/M	MEDIDA
XKR-10-13	1/1	1/2"
XKR-10-19	1/1	3/4"

CORTE, AJUSTE Y LISTO

LAS CONEXIONES **ALFA-EASY** LE AYUDAN A CONECTAR: **PPR**



NO REQUIERE SOLDADURA



MARQUE EL TUBO EN LA PROFUNDIDAD DEMOSTRADA



INSERTE EL TUBO



GIRE EL TUBO MIENTRAS LO INSERTA EN LA CONEXIÓN HASTA LA MARCA



USO
INDUSTRIAL
RESIDENCIAL



TIPO
COMPRESIÓN



MATERIAL
LATÓN

TEE

- Conexión rápida.
- De PVC.



CLAVE	C/M	MEDIDA
DPP711-20C	20/120	20 mm
DPP711-25C	20/120	25 mm

TAPÓN CAPA

- Conexión rápida.
- De PVC.



CLAVE	C/M	MEDIDA
XAPP-1020C	20/240	20 mm
XAPP-1025C	20/240	25 mm

COPE

- Conexión rápida.
- De PVC.



CLAVE	C/M	MEDIDA
XSPR10-20C	20/240	20 mm
XSPR10-25C	20/240	25 mm

COPE REDUCIDO

- Conexión rápida.
- De PVC.



CLAVE	C/M	MEDIDA
XRPP-2520C	20/240	20mmx25mm

CONECTOR MACHO

- Conexión rápida.
- De PVC.



CLAVE	C/M	MEDIDA
XMPP-2013C	20/240	20mmx13mm
XMPP-2519C	20/240	25mmx20mm

CONECTOR HEMBRA

- Conexión rápida.
- De PVC.



CLAVE	C/M	MEDIDA
XHPP-2013C	20/240	20mmx13mm
XHPP-2519C	20/240	13mmx20mm

CODO

- Conexión rápida.
- De PVC.



CLAVE	C/M	MEDIDA
XSCPP0-20C	20/240	20mmx20mm
XSCPP0-25C	20/240	25mmx25mm

EXTRACTOR DE TUBO

- Para conexión rápida.
- De plástico.
- Sistema CTS.



CLAVE	MEDIDA
XHE-13C	1/2"
XHE-19C	3/4"

EXTRACTOR DE TUBO

- Para conexión rápida.
- De plástico.
- Sistema métrico.



CLAVE	MEDIDA
XHE-20C	20 mm
XHE-25C	25 mm



CODO

- De 90°

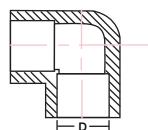

CLAVE	C/M	MEDIDA (D)
XSCPP10-20	50/500	20mm
XSCPP10-25	32/288	25mm
XSCPP10-32	15/90	32mm

CODO

- De 45°

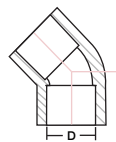

CLAVE	C/M	MEDIDA (D)
XSCPP11-20	24/240	20mm
XSCPP11-25	24/240	25mm
XSCPP11-32	15/105	32mm

CODO

- De 90°
- Rosca exterior.

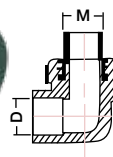

CLAVE	C/M	MEDIDA (D-M)
XOPP-20-13	12/144	20mm-1/2"
XOPP-20-19	8/96	20mm-3/4"
XOPP-25-19	7/70	25mm-3/4"

CODO

- De 90°
- Rosca interior.

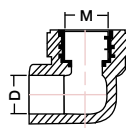

CLAVE	C/M	MEDIDA (D-M)
XSCPP20-13	12/192	20mm-1/2"
XSCPP20-19	15/120	20mm-3/4"
XSCPP25-13	12/192	25mm-1/2"
XSCPP25-19	15/120	25mm-3/4"

CODO CON SOPORTE

- De 90°
- Rosca interior.

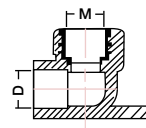

CLAVE	C/M	MEDIDA (D-M)
XCPP-20-13	8/96	20mm-1/2"
XCPP-25-13	8/96	25mm-1/2"

TEE

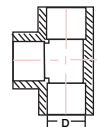

CLAVE	C/M	MEDIDA (D)
DPP-711-20	25/400	20mm
DPP-711-25	16/144	25mm
DPP-711-32	1/1	32mm

TEE

- Rosca exterior.

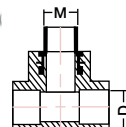

CLAVE	C/M	MEDIDA (D-M)
XNPP-20-13	8/96	20mm-1/2"
XNPP-20-19	8/72	25mm-3/4"

TEE

- Rosca interior.

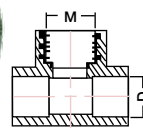

CLAVE	C/M	MEDIDA (D-M)
XDPP-20-13	8/128	20mm-1/2"
XDPP-20-19	8/128	20mm-3/4"
XDPP-25-13	8/72	25mm-1/2"
XDPP-32-25	1/1	32mm - 1"

TEE REDUCIDA

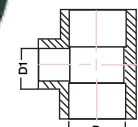

CLAVE	C/M	MEDIDA (DxDxD1)
XSPP-25-20	16/256	25x25x20mm
XSPP-32-25	1/1	32x32x25mm

CONEXIÓN

- Rosca exterior.

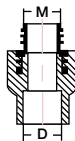

CLAVE	C/M	MEDIDA (D-M)
XMPP-20-13	25/150	20mm-1/2"
XMPP-25-13	15/270	25mm-1/2"
XMPP-25-19	25/125	25mm-3/4"
XMPP-32-19	10/80	32mm-3/4"

CONEXIÓN

- Rosca interior.

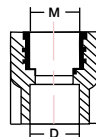

CLAVE	C/M	MEDIDA (D-M)
XHPP-20-13	30/270	20 mm-1/2"
XHPP-20-19	20/200	20 mm-3/4"
XHPP-25-13	15/150	25mm-1/2"
XHPP-25-19	15/150	25 mm-3/4"
XHPP-32-25	10/80	32 mm - 1"

COPLE

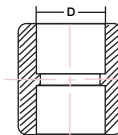

CLAVE	C/M	MEDIDA (D)
XSPR-10-20	80/400	20mm
XSPR-10-25	60/300	25mm
XSPR-10-32	1/1	32mm

COPLE REDUCIDO

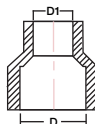

CLAVE	C/M	MEDIDA (DxD1)
XRPP-25-20	30/300	25mmx20mm
XRPP-32-25	20/160	32mmx25mm

TAPÓN CAPA

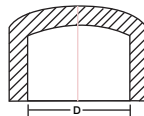

CLAVE	C/M	MEDIDA (D)
XAPP-10-20	125/750	20mm
XAPP-10-25	100/500	25mm
XAPP-10-32	50/250	32mm

TUERCA UNIÓN

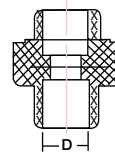

CLAVE	C/M	MEDIDA (D)
XTPP-11-20	30/120	20 mm
XTPP-11-25	20/80	25 mm
XTPP-11-32	10/60	32 mm

VÁLVULA DE ESFERA

- Hembra.

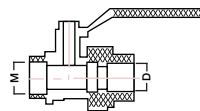

CLAVE	C/M	MEDIDA (DxM)
XSB-P20H13	5/60	20 mm 1/2"
XSB-P25H19	5/50	25 mm 1/2"
XSB-P32H25	2/30	32 mm 1"

VÁLVULA DE ESFERA

- Macho.

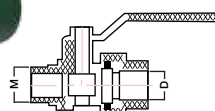

CLAVE	C/M	MEDIDA (DxM)
XSB-P20M13	5/60	20 mm 1/2"
XSB-P25M19	5/50	25 mm 1/2"
XSB-P32M25	2/30	32 mm 1"

VÁLVULA DE ESFERA

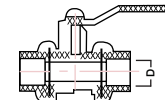

CLAVE	C/M	MEDIDA (D)
XSB-PPR-20	5/60	20 mm
XSB-PPR-25	5/40	25 mm
XSB-PPR-32	3/30	32 mm

TUBERÍA DE PPR

- De 4.0 mts.



CLAVE	C/M	MEDIDA (D)
XCTP-11-20	20	20 mm
XCTP-11-25	20	25 mm

KIT DE TERMOFUSIÓN PARA PPR

- 600 W

- 110 V~

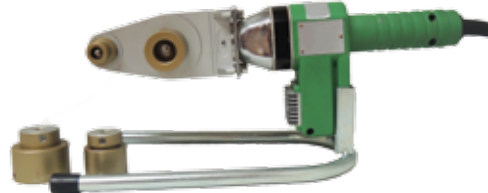

CLAVE	C/M	DETALLES
XK-PPR-TRM	1/6	3 DADOS

KIT PARA REGADERA DE PPR



CLAVE	C/M	MEDIDA
Z-KITPPR	1/16	20mm



PP

CODO

- De 90°.
- Rosca hembra.

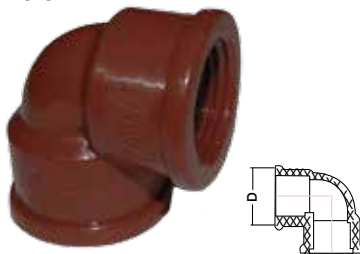

CLAVE	C/M	MEDIDA (D)
XSCPR10-13	50/600	1/2"
XSCPR10-19	50/400	3/4"
XSCPR10-25	50/200	1"

TEE

- Rosca hembra.

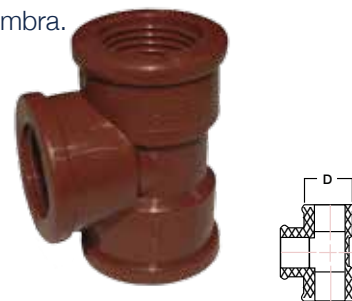

CLAVE	C/M	MEDIDA (D)
DPR-711-13	50/450	1/2"
DPR-711-19	50/250	3/4"
DPR-711-25	50/120	1"

TUERCA UNIÓN

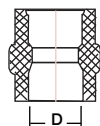

CLAVE	C/M	MEDIDA (D)
TPR-11-13	50/300	1/2"
TPR-11-19	50/200	3/4"
TPR-11-25	50/150	1"

COPELE HEMBRA

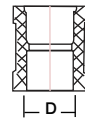

CLAVE	C/M	MEDIDA (D)
XSPRO-1013	50/850	1/2"
XSPRO-1019	50/550	3/4"
XSPRO-1025	50/300	1"

COPELE MACHO

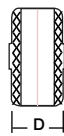

CLAVE	C/M	MEDIDA (D)
XIPR-10-13	50/1500	1/2"
XIPR-10-19	50/840	3/4"
XIPR-10-25	50/450	1"

TAPÓN MACHO

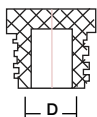

CLAVE	C/M	MEDIDA (D)
XGAR-10-13	50/1500	1/2"
XGAR-10-19	50/840	3/4"
XGAR-10-25	50/450	1"

TAPÓN HEMBRA

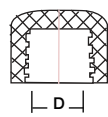

CLAVE	C/M	MEDIDA (D)
XSARO-1013	50/1500	1/2"
XSARO-1019	50/840	3/4"
XSARO-1025	50/450	1"

NIPLE

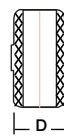

CLAVE	C/M	MEDIDA (D)
XGNP-10-13	50/1500	1/2"
XGNP-10-19	50/840	3/4"
XGNP-10-25	50/450	1"

CODO

- De 45°.

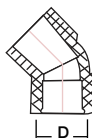

CLAVE	C/M	MEDIDA (D)
XSCPR11-13	50/1500	1/2"
XSCPR11-19	50/840	3/4"
XSCPR11-25	50/450	1"

HERRAMIENTA

- De roscado.



CLAVE	C/M	MEDIDA
XPR-202532	50/1500	20-25-32

TUBERÍA

- Dos capas.
- De 4.0 mts.



CLAVE	C/M	MEDIDA
XCT-PR-13	50/1500	1/2" x 3.4mm
XCT-PR-19	50/840	3/4" x 3.9mm
XCT-PR-25	50/450	1" x 4.9mm



P
V
C
C
E
D
4
0

CODO

- De 90°

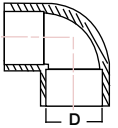

CLAVE	C/M	MEDIDA (D)
XSC4-10-13	100/700	1/2"
XSC4-10-19	35/350	3/4"
XSC4-10-25	30/240	1"
XSC4-10-32	15/150	1-1/4"
XSC4-10-38	5/90	1-1/2"
XSC4-10-51	2/58	2"
XSC4-10-76	2/20	3"
XSC4-10102	2/10	4"

CODO

- De 45°



CLAVE	C/M	MEDIDA (D)
XSC4-11-13	100/900	1/2"
XSC4-11-19	60/480	3/4"
XSC4-11-25	50/300	1"
XSC4-11-32	11/65	1-1/4"
XSC4-11-38	8/112	1-1/2"
XSC4-11-51	6/72	2"
XSC4-11-76	6/36	3"
XSC4-11-12	5/20	4"

CODO

- De 90°

- Con inserto de latón.
- Rosca interior.

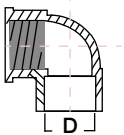

CLAVE	C/M	MEDIDA (D)
XSC4-20-13	1/1	1/2"

TEE

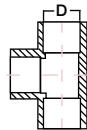

CLAVE	C/M	MEDIDA (D)
D4-711-13	50/400	1/2"
D4-711-19	50/250	3/4"
D4-711-25	30/150	1"
D4-711-32	10/80	1-1/4"
D4-711-38	6/60	1-1/2"
D4-711-51	4/40	2"
D4-711-76	1/15	3"
D4-711-102	1/6	4"

TEE REDUCIDA

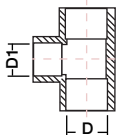

CLAVE	C/M	MEDIDA (DxDxD1)
XSE4-19-13	30/330	3/4"x3/4"x1/2"
XSE4-25-13	20/200	1"x1"x1/2"
XSE4-25-19	15/150	1"x1"x3/4"

ADAPTADOR

- Rosca exterior.

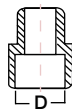

CLAVE	C/M	MEDIDA (D)
XSI4-10-13	200/1200	1/2"
XSI4-10-19	140/840	3/4"
XSI4-10-25	70/420	1"
XSI4-10-32	20/440	1-1/4"
XSI4-10-38	15/270	1-1/2"
XSI4-10-51	6/168	2"
XSI4-10-76	6/48	3"
XSI4-10-12	7/28	4"

ADAPTADOR

- Rosca interior.

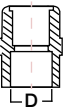

CLAVE	C/M	MEDIDA (D)
XSI4-20-13	150/900	1/2"
XSI4-20-19	50/600	3/4"
XSI4-20-25	50/300	1"
XSI4-20-32	24/216	1-1/4"
XSI4-20-38	20/180	1-1/2"
XSI4-20-51	8/112	2"
XSI4-20-76	10/60	3"
XSI4-20-12	6/26	4"

ADAPTADOR HEMBRA

- Con inserción de latón.
- Con rosca interior.

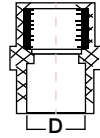

CLAVE	C/M	MEDIDA (D)
XSI4-12-13	150/900	1/2"

TAPÓN CAPA

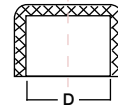

CLAVE	C/M	MEDIDA (D)
XSA4-10-13	150/1650	1/2"
XSA4-10-19	102/1224	3/4"
XSA4-10-25	120/720	1"
XSA4-10-32	45/450	1-1/4"
XSA4-10-38	36/360	1-1/2"
XSA4-10-51	4/196	2"
XSA4-10-76	4/60	3"
XSA4-10102	4/40	4"

TUERCA UNIÓN

- Rosca interior.

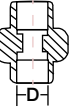

CLAVE	C/M	MEDIDA (D)
T4-10-13	20/300	1/2"
T4-10-19	50/200	3/4"
T4-10-25	12/120	1"
T4-10-32	8/80	1-1/4"
T4-10-38	6/60	1-1/2"
T4-10-51	5/45	2"
T4-10-63	2/16	2-1/2"
T4-10-102	1/6	4"

TUERCA UNIÓN

- Cementar.

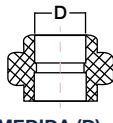

CLAVE	C/M	MEDIDA (D)
T4-11-13	60/360	1/2"
T4-11-19	30/210	3/4"
T4-11-25	20/140	1"
T4-11-32	5/70	1-1/4"
T4-11-38	6/54	1-1/2"
T4-11-51	2/30	2"
T4-11-63	2/12	2-1/2"

REDUCCIÓN CAMPANA

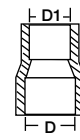

CLAVE	C/M	MEDIDA (DxD1)
XRA4-25-13	120/480	1" x 1/2"
XRA4-51-25	42/168	2" x 1"
XRA4-51-32	10/168	2" x 1-1/4"
XRA4-51-38	10/154	2" x 1-1/2"
XRA4-76-51	10/105	3" x 2"
XRA4-12-76	6/48	4" x 3"

REDUCCIÓN BUSHING

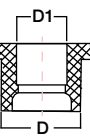

CLAVE	C/M	MEDIDA (DxD1)
XSR4-19-13	200/1400	3/4" x 1/2"
XSR4-25-19	143/858	1" x 3/4"
XSR4-38-32	35/350	1-1/2" x 1-1/4"
XSR4-51-25	20/180	2" x 1"
XSR4-51-38	89/178	2" x 1-1/2"

VÁLVULA DE ESFERA

- Rosca NPT.

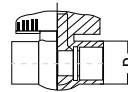

CLAVE	C/M	MEDIDA (D)
XS4B-10-13	134/268	1/2"
XS4B-10-19	20/140	3/4"
XS4B-10-25	14/84	1"
XS4B-10-32	4/52	1-1/4"
XS4B-10-38	4/48	1-1/2"
XS4B-10-51	2/24	2"
XS4B-10-63	2/8	2-1/2"
XS4B-10-76	1/8	3"
XS4B-10-12	1/6	4"

VÁLVULA DE ESFERA

- Cementar.

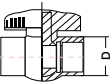

CLAVE	C/M	MEDIDA (D)
XS4B-20-13	134/268	1/2"
XS4B-20-19	21/168	3/4"
XS4B-20-25	11/111	1"
XS4B-20-32	6/60	1-1/4"
XS4B-20-38	4/48	1-1/2"
XS4B-20-51	2/24	2"
XS4B-20-63	2/16	2-1/2"
XS4B-20-76	1/8	3"
XS4B-20-12	1/6	4"

VÁLVULA DE ESFERA



CLAVE	C/M	MEDIDA (D)
XS4B-13-19	100/1000	1/2"

VÁLVULA OCTÁGONAL

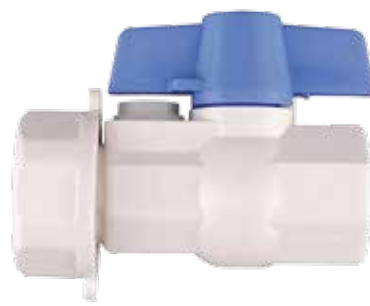

CLAVE	C/M	MEDIDA (D)
XS4B-47-13	100/1000	1/2"

VÁLVULA

- Con niple y tuerca.



CLAVE	C/M	MEDIDA (D)
XS4B-48-13	100/1000	1/2"

LLAVE CONTENCIÓN

- Corta.



alfa
NUEVO

LLAVE CORTE

- Antifraude.
- Corta.



alfa
NUEVO

LLAVE INCORPORACIÓN

- Antifraude.



alfa
NUEVO

PROX.
MAY

PROX.
MAY

PROX.
MAY

CLAVE	C/M	MEDIDA
XS8B-10-13	100/1000	1/2"x1/2"

CLAVE	C/M	MEDIDA
XS8C-10-13	100/1000	1/2"x1/2"

CLAVE	C/M	MEDIDA
XS8C-11-13	100/1000	20mmx1/2"

COPE

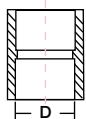

COPE

- Compresión.

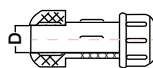

LLAVE CORTE

- Antifraude.



alfa
NUEVO

PROX.
MAY

CLAVE	C/M	MEDIDA (D)
XSP4-10-13	100/1000	1/2"
XSP4-10-19	100/600	3/4"
XSP4-10-25	50/350	1"
XSP4-10-32	5/220	1-1/4"
XSP4-10-38	6/180	1-1/2"
XSP4-10-51	2/112	2"
XSP4-10-76	5/75	3"

CLAVE	C/M	MEDIDA (D)
XLC4-10-13	1/214	1/2"
XLC4-10-19	5/125	3/4"
XLC4-10-25	7/98	1"

CLAVE	C/M	MEDIDA
XS8C-12-13	100/1000	20mmx1/2"

TUBERÍA DE PVC

CEDULA 40.

- Tubo de 6.1 mts.



PEGAMENTO

- Para tubería y conexiones de PVC sanitario.



CLAVE	C/M	MEDIDA
XC-01-060	30/30	60 ml
XC-01-140	24/24	118 ml
XC-01-220	24/24	236 ml
XC-01-460	12/12	473 ml

PEGAMENTO AZUL

- Para tubería y conexiones de PVC.
- Condiciones húmedas.



CLAVE	C/M	MEDIDA
XC-03-060	30/30	60 ml
XC-03-118	24/24	118 ml
XC-03-236	24/24	236 ml



P
V
C
C
E
D
4
0

COPE

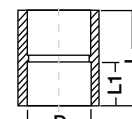

CLAVE	C/M	MEDIDA (D)
XSP8-10-13	60/600	1/2"
XSP8-10-19	40/400	3/4"
XSP8-10-25	24/240	1"
XSP8-10-32	1/199	1-1/4"
XSP8-10-38	1/140	1-1/2"
XSP8-10-51	1/81	2"

CODO

- De 90°

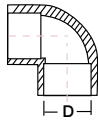

CLAVE	C/M	MEDIDA (D)
XSC8-10-13	50/500	1/2"
XSC8-10-19	30/270	3/4"
XSC8-10-25	20/160	1"
XSC8-10-32	1/99	1-1/4"
XSC8-10-38	1/72	1-1/2"
XSC8-10-51	1/41	2"
XSC8-10-63	1/36	2-1/2"
XSC8-10-76	1/15	3"
XSC8-10-12	1/12	4"

CODO

- De 45°



CLAVE	C/M	MEDIDA (D)
XSC8-11-13	50/500	1/2"
XSC8-11-19	30/300	3/4"
XSC8-11-25	20/180	1"
XSC8-11-32	1/120	1-1/4"
XSC8-11-38	1/90	1-1/2"
XSC8-11-51	1/48	2"

TEE

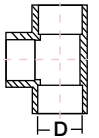

CLAVE	C/M	MEDIDA (D)
D8-711-13	30/300	1/2"
D8-711-19	20/180	3/4"
D8-711-25	10/100	1"
D8-711-32	1/70	1-1/4"
D8-711-38	1/52	1-1/2"
D8-711-51	1/32	2"
D8-711-63	1/1	2-1/2"
D8-711-76	1/1	3"
D8-711-120	1/1	4"

TEE REDUCIDA

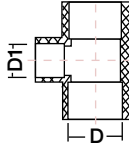

CLAVE	C/M	MEDIDA (DxD1)
XSE8-19-13	20/200	3/4" x 1/2"
XSE8-25-13	12/120	1" x 1/2"
XSE8-25-19	11/110	1" x 3/4"

REDUCCIÓN BUSHING

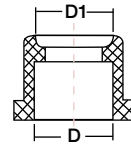

CLAVE	C/M	MEDIDA (DxD1)
XSR8-19-13	80/800	3/4" x 1/2"
XSR8-25-19	52/520	1" x 3/4"
XSR8-38-32	30/270	1-1/2" x 1-1/4"
XSR8-51-38	1/154	2" x 1-1/2"

TAPÓN CAPA

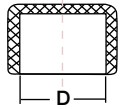

CLAVE	C/M	MEDIDA (D)
XSA8-10-13	115/1150	1/2"
XSA8-10-19	70/700	3/4"
XSA8-10-25	40/400	1"
XSA8-10-32	1/317	1-1/4"
XSA8-10-38	1/240	1-1/2"
XSA8-10-51	1/146	2"

TUERCA UNIÓN

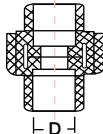

CLAVE	C/M	MEDIDA (D)
T8-11-13	30/300	1/2"
T8-11-19	18/180	3/4"
T8-11-25	15/120	1"
T8-11-32	1/96	1-1/4"
T8-11-38	1/48	1-1/2"
T8-11-51	1/36	2"

ADAPTADOR

- Con rosca interior.

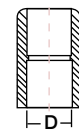

CLAVE	C/M	MEDIDA (D)
XSI8-20-13	65/650	1/2"
XSI8-20-19	40/400	3/4"
XSI8-20-25	24/240	1"
XSI8-20-32	1/198	1-1/4"
XSI8-20-38	1/139	1-1/2"
XSI8-20-51	1/72	2"

ADAPTADOR

- Con rosca exterior.

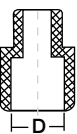

CLAVE	C/M	MEDIDA (D)
XSI8-10-13	85/850	1/2"
XSI8-10-19	55/550	3/4"
XSI8-10-25	35/315	1"
XSI8-10-32	20/200	1-1/4"
XSI8-10-38	1/200	1-1/2"
XSI8-10-51	1/130	2"

BRIDA

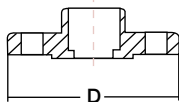

CLAVE	C/M	MEDIDA (D)
XBR8-10-51	1/35	2"
XBR8-10-76	1/15	3"
XBR8-10-12	1/10	4"

VÁLVULA DE ESFERA

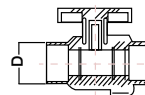

CLAVE	C/M	MEDIDA (D)
XSB8-20-13	10/90	1/2"
XSB8-20-19	5/75	3/4"
XSB8-20-25	3/48	1"
XSB8-20-32	3/24	1-1/4"
XSB8-20-38	2/20	1-1/2"
XSB8-20-51	2/16	2"
XSB8-20-12	1/2	4"

TUBERÍA CED 80

- Tubo de 6.1 mts.



CLAVE	C/M	MEDIDA
XST8-13-06	1/1	1/2"
XST8-19-06	1/1	3/4"



CPVC

CODO

- De 90°

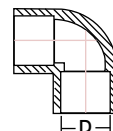

CLAVE	C/M	MEDIDA (D)
XSCP-10-13	150/1500	1/2"
XSCP10-13L	160/1600	1/2"
XSCP-10-19	65/650	3/4"
XSCP-10-25	30/300	1"
XSCP-10-32	17/170	1-1/4"
XSCP-10-38	10/100	1-1/2"
XSCP-10-51	6/48	2"

CODO

- De 45°

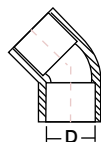

CLAVE	C/M	MEDIDA (D)
XSCP-11-13	180/1800	1/2"
XSCP-11-19	75/750	3/4"
XSCP-11-25	35/350	1"
XSCP-11-32	20/200	1-1/4"
XSCP-11-38	12/120	1-1/2"
XSCP-11-51	7/56	2"

CODO REDUCIDO

- De 90°



CLAVE	C/M	MEDIDA
XSCP-13-19	80/800	1/2" x 3/4"

CODO

- De 90°

- Con rosca interior de latón.

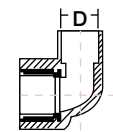

CLAVE	C/M	MEDIDA (D)
XSCP-20-13	65/325	1/2"

CODO

- De 90°

- Con rosca exterior de latón.

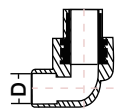

CLAVE	C/M	MEDIDA (D)
XSCP-21-13	24/240	1/2"

CODO CON SOPORTE

- De 90°

- Con rosca interior.

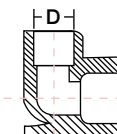

CLAVE	C/M	MEDIDA (D)
XSCP-12-13	45/450	1/2"

TEE

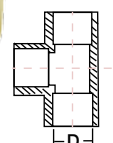

CLAVE	C/M	MEDIDA (D)
DP-711-13L	105/1050	1/2"
DP-711-19	40/400	3/4"
DP-711-25	20/200	1"
DP-711-32	10/100	1-1/4"
DP-711-38	6/60	1-1/2"
DP-711-51	1/40	2"

TEE REDUCIDA

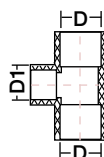

CLAVE	C/M	MEDIDA (DxDxD1)
XSEP-19-13	55/550	3/4 X 3/4 X 1/2
XSEP-25-13	18/180	1 X 1 X 1/2
XSEP-25-19	14/140	1 X 1 X 3/4
XSEP-38-32	10/80	1-1/2 X 1-1/4
XSEP-51-32	5/50	2 X 1-1/4
XSEP-51-38	5/50	2 X 1-1/2

TEE MACHO

- Con inserto de latón.

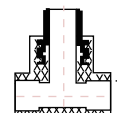

CLAVE	C/M	MEDIDA (D)
DPM-711-13	36/180	1/2"
DPM-711-19	19/95	3/4"
DPM-711-25	5/50	1"

TEE HEMBRA

- Con inserto de latón.

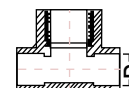

CLAVE	C/M	MEDIDA (D)
DPH-711-13	48/240	1/2"
DPH-711-19	26/130	3/4"
DPH-711-25	14/70	1"

CRUZ

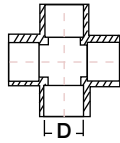

CLAVE	C/M	MEDIDA (D)
XCCP-10-13	75/750	1/2"
XCCP-10-19	30/300	3/4"
XCCP-10-25	15/150	1"

YEE

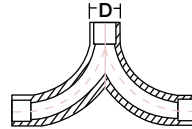

CLAVE	C/M	MEDIDA (D)
XYP-711-13	20/200	1/2"

COPE

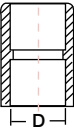

CLAVE	C/M	MEDIDA (D)
XSPP-10-13	250/2500	1/2"
XSPP-10-19	100/1000	3/4"
XSPP-10-25	50/500	1"
XSPP-10-32	30/270	1-1/4"
XSPP-10-38	20/200	1-1/2"
XSPP-10-51	24/96	2"

COPE

- De reparación.

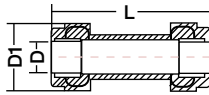

CLAVE	C/M	MEDIDA (D)
XLCP-10-13	26/260	1/2"
XLCP-10-19	15/150	3/4"
XLCP-10-25	10/100	1"

TUERCA UNIÓN

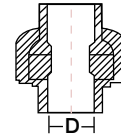

CLAVE	C/M	MEDIDA (D)
TP-11-13	120/600	1/2"
TP-11-19	35/350	3/4"
TP-11-25	20/200	1"
TP-11-32	15/120	1-1/4"
TP-11-38	12/72	1-1/2"
TP-11-51	8/40	2"

ADAPTADOR

- Con rosca exterior.

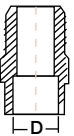

CLAVE	C/M	MEDIDA (D)
XSIP-10-13	170/1700	1/2"
XSIP-10-19	95/950	3/4"
XSIP-10-25	50/500	1"
XSIP-10-32	28/280	1-1/4"
XSIP-10-38	25/200	1-1/2"

ADAPTADOR

- Con rosca interior.

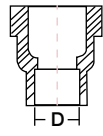

CLAVE	C/M	MEDIDA (D)
XSIP-20-13	120/1200	1/2"
XSIP-20-19	70/700	3/4"
XSIP-20-25	40/400	1"
XSIP-20-32	22/220	1-1/4"
XSIP-20-38	16/160	1-1/2"

ADAPTADOR

- Con rosca exterior de latón.

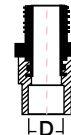

CLAVE	C/M	MEDIDA (D)
XSIP-11-13	30/300	1/2"
XSIP-11-19	20/200	3/4"
XSIP-11-25	10/100	1"
XSIP-11-32	15/60	1-1/4"

ADAPTADOR

- Con rosca interior de latón.

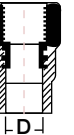

CLAVE	C/M	MEDIDA (D)
XSIP-12-13	68/340	1/2"
XSIP-12-19	20/200	3/4"
XSIP-12-25	25/100	1"
XSIP-12-32	15/60	1-1/4"

ADAPTADOR LIGERO

- Con rosca exterior de latón.

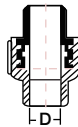

CLAVE	C/M	MEDIDA (D)
XSIP-1113L	65/325	1/2"
XSIP-1119L	20/200	3/4"
XSIP-1125L	10/100	1"

ADAPTADOR LIGERO

- Con rosca interior de latón.

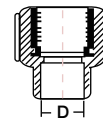

CLAVE	C/M	MEDIDA (D)
XSIP-1213L	85/425	1/2"
XSIP-1219L	52/260	3/4"
XSIP-1225L	28/140	1"

REDUCCIÓN BUSHING

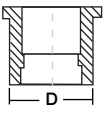

CLAVE	C/M	MEDIDA (DxD1)
XSRP-19-13	230/2300	3/4" x 1/2"
XSRP-25-13	105/1050	1" x 1/2"
XSRP-25-19	105/1050	1" x 3/4"
XSRP-32-25	60/600	1-1/4" x 1"
XSRP-38-32	38/380	1-1/2" x 1"
XSRP-51-38	20/200	2" x 1-1/2"

TAPÓN CAPA

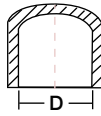

CLAVE	C/M	MEDIDA (D)
XSAP-10-13	450/4500	1/2"
XSAP-10-19	180/1800	3/4"
XSAP-10-25	90/900	1"
XSAP-10-32	52/520	1-1/4"
XSAP-10-38	35/350	1-1/2"
XSAP-10-51	16/160	2"

VÁLVULA DE ESFERA

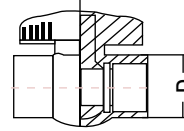

CLAVE	C/M	MEDIDA (D)
XSCB-20-13	30/300	1/2"
XSCB-20-19	20/200	3/4"
XSCB-20-25	10/100	1"
XSCB-20-32	4/52	1-1/4"
XSCB-20-38	1/50	1-1/2"
XSCB-20-51	7/28	2"

LLAVE DE EMPOTRAR

- De CPVC
- Juego de 2 piezas.

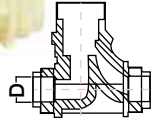

CLAVE	C/M	MEDIDA (D)
XK-10-852	1/72	1/2"

VÁLVULA DE GLOBO

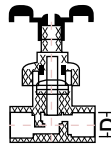

CLAVE	C/M	MEDIDA (D)
XGCP-10-13	15/165	1/2"

VÁLVULA ANGULAR

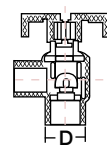

CLAVE	C/M	MEDIDA (D)
PCP-40-13	40/400	1/2"

GRAPA PARA TUBERÍA

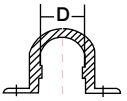
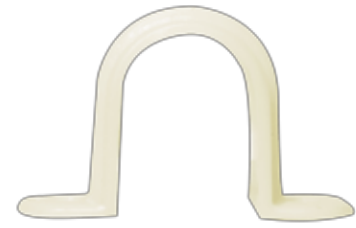

CLAVE	C/M	MEDIDA (D)
XPHP-10-13	600/6000	1/2"

PEGAMENTO

- Para tubería y conexiones de CPVC.



CLAVE	C/M	MEDIDA
XC-02-060	30/30	60 ml
XC-02-118	24/24	118 ml
XC-02-236	24/24	236 ml
XC-02-473	12/12	473 ml

LLAVES DE EMPOTRAR

- De latón.
- Para CPVC.
- Cartucho de compresión.
- Roscable.
- Juego de 2 piezas.

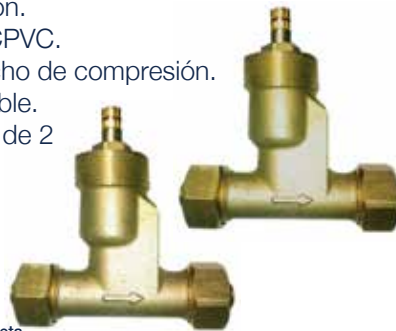

CLAVE	C/M	MEDIDA
XK-10-752	1/40	1/2"

KIT PARA REGADERA DE CPVC

- 1 codo oreja 90° x 1/2"
- 1 yee 1/2"
- 2 codos 90° x 1/2"
- 2 manerales con chapetón
- 2 llaves de empotrar

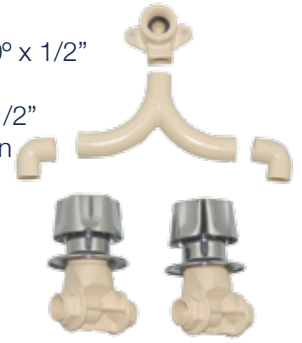

CLAVE	C/M	MEDIDA
Z-KITCPVC	1/1	1/2"

TUBERÍA DE CPVC

- Tipo: RD 11
- Tubo de 6.1 mts.



CLAVE	C/M	MEDIDA
XCT-13-006	20	1/2"
XCT-19-006	15	3/4"
XCT-25-006	12	1"

TUBERÍA DE CPVC

- Tipo: RD 13.5
- Tubo de 6.1 mts.



CLAVE	C/M	MEDIDA
XCT-13-136	20	1/2"
XCT-19-136	15	3/4"
XCT-25-136	12	1"



GALVANIZADO

CODO GALVANIZADO
- De 90°
- Clase: 150 lbs.



CLAVE	C/M	MEDIDA
XGC-10-13	40/400	1/2"
XGC-10-19	21/210	3/4"
XGC-10-25	6/60	1"
XGC-10-32	8/64	1-1/4"
XGC-10-38	6/48	1-1/2"
XGC-10-51	4/32	2"
XGC-10-63	2/16	2-1/2"
XGC-10-76	2/10	3"
XGC-10-102	1/6	4"

CODO GALVANIZADO
- De 45°
- Clase: 150 lbs.



CLAVE	C/M	MEDIDA
XGC-11-13	40/400	1/2"
XGC-11-19	24/240	3/4"
XGC-11-25	14/140	1"
XGC-11-32	12/96	1-1/4"
XGC-11-38	9/72	1-1/2"
XGC-11-51	6/36	2"
XGC-11-63	2/20	2-1/2"
XGC-11-76	2/12	3"
XGC-11-102	1/6	4"

TEE GALVANIZADA
- Clase: 150 lbs.



CLAVE	C/M	MEDIDA
XGE-10-13	24/240	1/2"
XGE-10-19	14/140	3/4"
XGE-10-25	9/90	1"
XGE-10-32	8/56	1-1/4"
XGE-10-38	4/40	1-1/2"
XGE-10-51	5/20	2"
XGE-10-63	2/12	2-1/2"
XGE-10-76	2/10	3"
XGE-10-102	1/4	4"

COPLE GALVANIZADO
- Clase: 150 lbs.



CLAVE	C/M	MEDIDA
XGP-10-13	45/450	1/2"
XGP-10-19	30/300	3/4"
XGP-10-25	18/180	1"
XGP-10-32	12/120	1-1/4"
XGP-10-38	9/72	1-1/2"
XGP-10-51	8/48	2"
XGP-10-63	4/32	2-1/2"
XGP-10-76	4/24	3"
XGP-10-102	1/10	4"

NIPLE GALVANIZADO CED. 40
- De 1/2".
- Clase: 150 lbs.



CLAVE	C/M	MEDIDA
XGN-13-038	50/500	1/2" x 1-1/2"
XGN-13-051	50/500	1/2" x 2"
XGN-13-063	30/300	1/2" x 2-1/2"
XGN-13-076	30/300	1/2" x 3"
XGN-13-102	20/200	1/2 x 4"
XGN-13-150	15/150	1/2" x 6"
XGN-13-200	12/120	1/2" x 8"
XGN-13-250	10/100	1/2" x 10"
XGN-13-300	10/100	1/2" x 12"

TAPÓN MACHO GALVANIZADO
- Clase: 150 lbs.



TAPÓN HEMBRA GALVANIZADO
- Clase: 150 lbs.



TUERCA UNIÓN GALVANIZADA
- Clase: 150 lbs.



CLAVE	C/M	MEDIDA
XGA-10-13	90/900	1/2"
XGA-10-19	60/600	3/4"
XGA-10-25	30/300	1"
XGA-10-32	30/300	1-1/4"
XGA-10-38	20/200	1-1/2"
XGA-10-051	8/80	2"
XGA-10-63	8/64	2-1/2"
XGA-10-76	4/36	3"
XGA-10-102	4/36	4"

CLAVE	C/M	MEDIDA
XGA-11-13	70/700	1/2"
XGA-11-19	50/500	3/4"
XGA-11-25	26/167	1"
XGA-11-32	10/100	1-1/4"
XGA-11-38	8/80	1-1/2"
XGA-11-51	5/100	2"
XGA-11-63	5/70	2-1/2"
XGA-11-76	2/10	3"
XGA-11-102	2/20	4"

CLAVE	C/M	MEDIDA
XGD-10-13	18/180	1/2"
XGD-10-19	12/120	3/4"
XGD-10-25	11/88	1"
XGD-10-32	10/30	1-1/4"
XGD-10-38	6/36	1-1/2"
XGD-10-51	4/28	2"
XGD-10-63	2/12	2-1/2"
XGD-10-76	2/10	3"
XGD-10-102	1/6	4"

NIPLE GALVANIZADO CED. 40

- De 1/2".
- Clase: 150 lbs.



CLAVE	C/M	MEDIDA
XGN-13-40	10/500	1/2" x 40cm
XGN-13-50	10/500	1/2" x 50 cm
XGN-13-60	10/300	1/2" x 60 cm
XGN-13-065	30/300	1/2" x 65 cm
XGN-13-70	10/200	1/2" x 70 cm
XGN-13-80	10/100	1/2" x 80 cm

NIPLE GALVANIZADO CED. 40

- De 3/4".
- Clase: 150 lbs.



CLAVE	C/M	MEDIDA
XGN-19-038	30/300	3/4" x 1-1/2"
XGN-19-051	30/300	3/4" x 2"
XGN-19-063	30/300	3/4" x 2-1/2"
XGN-19-076	20/200	3/4" x 3"
XGN-19-102	15/150	3/4" x 4"
XGN-19-150	10/100	3/4" x 6"
XGN-19-200	10/100	3/4" x 8"

NIPLE GALVANIZADO CED 40.

- De 1".
- Clase: 150 lbs.



CLAVE	C/M	MEDIDA
XGN-25-51	20/200	1" x 2"
XGN-25-63	15/150	1" x 2-1/2"
XGN-25-76	10/100	1" x 3"
XGN-25-102	10/100	1" x 4"
XGN-25-150	8/80	1" x 6"
XGN-25-200	5/50	1" x 8"

NIPLE CUERDA CORRIDA GALVANIZADO

- Clase: 150 lbs.



CLAVE	C/M	MEDIDA
XGN-13-CC	80/800	1/2"
XGN-19-CC	50/500	3/4"
XGN-25-CC	20/200	1"
XGN-32-CC	15/150	1-1/4"
XGN-38-CC	10/100	1-1/2"
XGN-51-CC	9/63	2"

NIPLE BOTELLA GALVANIZADO

- Clase: 150 lbs.



CLAVE	C/M	MEDIDA
XGN-13B	30/300	1/2"
XGN-19B	20/200	3/4"
XGN-25B	15/150	1"

NIPLE ESPIGA



CLAVE	C/M	MEDIDA
XGN-25E	10/100	1"
XGN-51E	5/30	2"

REDUCCIÓN CAMPANA GALVANIZADA

- Clase: 150 lbs.



CLAVE	C/M	MEDIDA
XGR-13-10A	50/500	1/2" - 3/8"
XGR-19-13A	36/360	3/4" - 1/2"
XGR-25-19A	20/200	1" - 3/4"
XGR-32-25A	12/120	1-1/4" - 1"
XGR-38-32A	10/100	1-1/2" - 1-1/4"
XGR-51-38A	6/48	2" - 1-1/2"

REDUCCIÓN BUSHING GALVANIZADO

- Clase: 150 lbs.



CLAVE	C/M	MEDIDA
XGR-19-13	60/600	3/4" - 1/2"
XGR-25-13	30/300	1" - 1/2"
XGR-25-19	30/300	1" - 3/4"

YEE GALVANIZADA

- Clase: 150 lbs.



CLAVE	C/M	MEDIDA
XGY-10-13	25/250	1/2"
XGY-10-19	12/120	3/4"
XGY-10-25	8/80	1"
XGY-10-32	6/18	1-1/4"
XGY-10-38	3/30	1-1/2"
XGY-10-51	2/20	2"

SELLADOR

- Para roscas.



CLAVE	C/M	MEDIDA
XKZ-14-00	1/40	60 ml
XKZ-14-01	1/30	118 ml

TUBERÍA NORMA X

- Tubo de 6.40 mts.

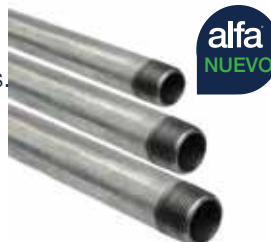

CLAVE	C/M	MEDIDA
XGT-09-13	1/1	1/2"
XGT-09-19	1/1	3/4"
XGT-09-25	1/1	1"
XGT-09-32	1/1	1" 1/4
XGT-09-38	1/1	1" 1/2
XGT-09-51	1/1	2"

TUBERÍA CED40

- Tubo de 6.40 mts.

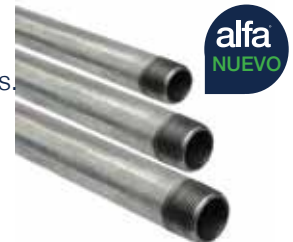

CLAVE	C/M	MEDIDA
XGT-10-13	1/1	1/2"
XGT-10-19	1/1	3/4"
XGT-10-25	1/1	1"
XGT-10-32	1/1	1" 1/4
XGT-10-38	1/1	1" 1/2
XGT-10-51	1/1	2"



CONEXIONES PARA GAS

PARA TUBERÍA DE COBRE Y TUBERÍA PE-AL-PE

Diámetros de tubería gas
 3/8" (1216)
 1/2" (1620)
 3/4" (2025)
 1" (2532)

TUBERÍA PE-AL-PE

- Color negro.
- Para gas.



CLAVE	ROLLO	MEDIDA
XKT-15-13A	100 m	3/8" - 1216
XKT-15-16A	100 m	1/2" - 1620

TUBERÍA PE-AL-PE

- Color negro.
- Para gas.



CLAVE	ROLLO	MEDIDA
XKT-12-13A	100 m	3/8" - 1216

TUBERÍA PARA USOS GENERALES

- Color amarillo.
- Para interiores.
- 150 PSI



CLAVE	ROLLO	MEDIDA
XKT-11-13A	100 m	3/8" - 1216

MANGUERA PARA USOS GENERALES

- Color negro.
- Tramada.
- 300 PSI.

NOM



CLAVE	ROLLO	DN
XGM-10-10N	100 m	10mm - 3/8"

MANGUERA PARA USOS GENERALES

- Color negro.
- Para gas.
- Tramada.



CLAVE	ROLLO	DN
XGM-10-1UN	100 m	10mm-3/8"

MANGUERA PARA USOS GENERALES

- Color amarillo.
- Para gas.
- Tramada.



CLAVE	ROLLO	DN
XGM-10-1UA	100 m	10mm - 3/8"



COPLÉ

- Para tubo PE-AL-PE.
- De **latón**.



CLAVE	C/M	MEDIDA
XL-53-13	20/360	1216
XL-53-16	10/300	1620
XL-53-19	10/160	2025
XL-53-25	5/100	2532

ADAPTADOR

- Rosca exterior NPT.
- Para tubo PE-AL-PE.
- De **latón**.



CLAVE	C/M	MEDIDA
XAK-10-13	20/320	1/2" - 1216
XAK-10-16	15/300	1/2" - 1620
XAK-10-19	15/240	3/4" - 2025
XAK-10-25	10/140	1" - 2532

ADAPTADOR

- Rosca interior NPT.
- Para tubo PE-AL-PE.
- De **latón**.



CLAVE	C/M	MEDIDA
XAK-20-13	20/480	1/2" - 1216
XAK-20-16	10/300	1/2" - 1620
XAK-20-19	15/240	3/4" - 2025
XAK-20-25	10/150	1" - 2532

CONECTOR FLARE

- Para tubo PE-AL-PE.
- De **latón**.



CLAVE	C/M	MEDIDA
XL-55-10	20/600	3/8" F - 1216
XL-55-16	20/400	3/8" F - 1620

ADAPTADOR

- De **latón**.
- Rosca exterior NPT.
- Para tubo PE-AL-PE.



CLAVE	C/M	MEDIDA
XL-54-10	20/600	3/8" NPT - 1216
XL-54-16	20/240	3/8" NPT - 1620

ADAPTADOR

- De **latón**.
- Soldable
- Para tubo PE-AL-PE.



CLAVE	C/M	MEDIDA
XL-56-13	20/600	1/2" S - 1216
XL-56-1613	20/600	1/2" S - 1620



REDUCCIÓN

- De **latón**.
- Para tubo PE-AL-PE.



CLAVE	C/M	MEDIDA
XL-57-1620	10/300	1216 - 1620
XL-57-2025	10/240	1216 - 2025

CODO

- Para tubo PE-AL-PE.
- De **latón**.



CLAVE	C/M	MEDIDA
XSC-53-13	10/220	1216 - 1216
XSC-53-16	10/220	1620 - 1620

CODO

- De **latón**.
- Rosca exterior NPT.
- Para tubo PE-AL-PE.



CLAVE	C/M	MEDIDA
XSC-54-13	20/440	1/2" - 1216

CODO

- De **latón**.
- Rosca interior NPT.
- Para tubo PE-AL-PE.



CLAVE	C/M	MEDIDA
XSC-55-13	20/400	1/2" - 1216

TEE

- Para tubo PE-AL-PE.
- De **latón**.



CLAVE	C/M	MEDIDA
XD-53-13	10/180	1216
XD-53-16	10/120	1620
XD-53-19	5/90	2025
XD-53-25	2/50	2532

TEE

- De **latón**.
- Rosca interior NPT.
- Para tubo PE-AL-PE.



CLAVE	C/M	MEDIDA
XD-55-13	10/250	1/2" - 1216

VÁLVULA DE ESFERA

- Para tubo PE-AL-PE.
- De **latón**.



CLAVE	C/M	MEDIDA
XSB-53-13	6/48	3/8" - 1216
XSB-53-16	15/120	1/2" - 1620

VÁLVULA DE ESFERA

- De **latón**.
- Rosca exterior NPT.
- Para tubo PE-AL-PE.



CLAVE	C/M	MEDIDA
XSB-54-13	26/130	1/2" NPT - 1216

VÁLVULA DE ESFERA

- De **latón**.
- Rosca hembra NPT.
- Uso: para gas.



CLAVE	C/M	MEDIDA
XSB-40-13	14/126	1/2"
XSB-40-19	8/72	3/4"
XSB-40-25	4/36	1"
XSB-40-32	1/10	1 1/4"
XSB-40-38	1/10	1 1/2"
XSB-40-51	1/10	2"

TUBERÍA ITALFA PARA AGUA

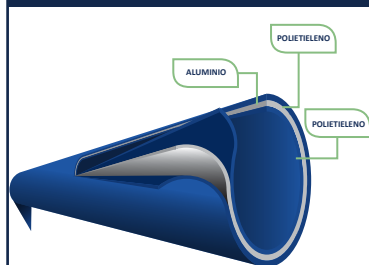

Diámetro de tubería agua
 1/2" (1216)
 5/8" (1620)
 3/4" (2025)
 1" (2532)

- Presión: 200 PSI.

- agua fría
- agua caliente

PE-AL-PE
XKT-10



PEX-AL-PEX
XKT-17



CLAVE	ROLLO	EMPAQUE	MEDIDA	TEMP.
XKT-10-13	100 m	N/A	12 - 16 mm	32° ●
XKT-10-13A	100 m	caja	12 - 16 mm	32° ●●
XKT-10-16A	100 m	caja	16 - 20 mm	32° ●●
XKT-10-19A	100 m	caja	20 - 25 mm	32° ●●
XKT-10-25A	100 m	caja	25 - 32 mm	32° ●●
XKT-17-13A	100 m	caja	12 - 16 mm	95° ●

TUBO PEX

- Tubería reticulada.
- Para agua fría y caliente.



CLAVE	ROLLO	MEDIDA
XKT-09-13A	● 100 m	1/2" 1216
XKT-09-16A	● 100 m	5/8" 1620
XKT-09-19A	● 100 m	3/4" 2025

CODO ESTUFA

- Flare a NPT.



CLAVE	C/M	MEDIDA
XCE-10-10	40/640	3/8" x 3/8"
XCE-10-13	40/560	3/8" x 1/2"
XCE-13-13	40/400	1/2" x 1/2"

CODO UNIÓN

- Flare a Flare.



CLAVE	C/M	MEDIDA
XCU-10-10	25/250	3/8" x 3/8"

CODO TERMINAL

- Flare a NPT.



CLAVE	C/M	MEDIDA
XCT-10-10	50/500	3/8" x 3/8"
XCT-10-13	25/250	3/8" x 1/2"
XCT-13-13	25/250	1/2" x 1/2"

NIPLE CAMPANA

- Flare a NPT.



CLAVE	C/M	MEDIDA
XNC-08-10	40/400	5/16" x 3/8"
XNC-08-13	40/400	5/16" x 1/2"
XNC-10-06	100/1000	3/8" x 1/4"
XNC-10-10	40/640	3/8" x 3/8"
XNC-10-13	40/620	3/8" x 1/2"
XNC-13-06	40/400	1/2" x 1/4"
XNC-13-10	40/400	1/2" x 3/8"
XNC-13-13	40/400	1/2" x 1/2"

NIPLE TERMINAL

- Flare a NPT.



CLAVE	C/M	MEDIDA
XNT-06-13	25/250	1/2" x 1/4"
XNT-08-10	25/400	5/16" x 3/8"
XNT-08-13	25/400	5/16" x 1/2"
XNT-10-04	25/250	3/8" x 1/8"
XNT-10-06	40/800	3/8" x 1/4"
XNT-10-10	50/1000	3/8" x 3/8"
XNT-10-13	40/560	3/8" x 1/2"
XNT-13-10	40/600	1/2" x 3/8"
XNT-13-13	40/400	1/2" x 1/2"

NIPLE UNIÓN

- Flare a Flare.



CLAVE	C/M	MEDIDA
XNU-08-00	40/400	5/16" x 5/16"
XNU-08-06	25/400	5/16" x 1/4"
XNU-10-10	40/800	3/8" x 3/8"
XNU-10-13	25/250	3/8" x 1/2"
XNU-13-13	25/250	1/2" x 1/2"

NIPLE TERMINAL

- Espiga a NPT.



CLAVE	C/M	MEDIDA
XNT-00-06	25/250	1/4" x 1/4"
XNT-00-10	25/250	3/8" x 3/8"
XNT-06-10	25/250	1/4" x 3/8"

TUERCA IZQUIERDA

- Pigtail.



CLAVE	C/M	MEDIDA
XTI-25-00	40/800	1"

TUERCA CÓNICA



CLAVE	C/M	MEDIDA
XTC-06-00	25/1700	1/4"
XTC-08-00	25/1500	5/16"
XTC-10-00	100/2000	3/8"
XTC-13-00	50/500	1/2"

TUERCA CÓNICA

- Reducida.



CLAVE	C/M	MEDIDA
XTR-10-16	50/500	3/8" x 5/16"
XTR-10-13	50/500	3/8" x 1/2"

TUERCA LOCA

- Con espiga.



CLAVE	C/M	MEDIDA
XTL-10-00	100/1000	3/8"

TEE TERMINAL

- Flare a NPT.



CLAVE	C/M	MEDIDA
XTT-10-00	40/400	3/8"

TEE UNIÓN

- Flare a Flare.



CLAVE	C/M	MEDIDA
XTU-10-00	25/500	3/8"

CONECTOR

- Flare a Soldable.



CLAVE	C/M	MEDIDA
XCS-10-13	40/640	3/8" x 1/2"

CONECTOR

- NPT a Soldable.



CLAVE	C/M	MEDIDA
XCF-10-13	50/1200	3/8" x 1/2"

PUNTA POOL

- Con espiga.



CLAVE	C/M	MEDIDA
XPE-10-00	20/600	3/8"
XPE-12-00	10/300	3/8"

PUNTA POOL

- Con rosca NPT.



CLAVE	C/M	MEDIDA
XPP-10-00	20/600	1/4"
XPP-12-00	10/300	1/4"

VÁLVULA DE ALIVIO



CLAVE	C/M	MEDIDA
XVA-00-00	10/700	1/2" x 1/2"

VÁLVULA DE PASO

- Flare a Flare.



CLAVE	C/M	MEDIDA
XV-10-10	24/240	3/8" x 3/8"

VÁLVULA DE PASO

- Soldable a Flare.



CLAVE	C/M	MEDIDA
XLP-14-13	20/200	1/2" x 3/8"

VÁLVULA DE PASO

- Rosca NPT a Flare.



CLAVE	C/M	MEDIDA
XLP-14-08	20/200	1/2" x 5/16"
XLP-14-10	20/200	1/2" x 3/8"

VÁLVULA DE CONTROL

- Con barril.



CLAVE	C/M	MEDIDA
XLP-14-10A	25/200	3/8" x 1/2"

VÁLVULA ANGEL

- De latón.
- Para gas.



CLAVE	C/M	MEDIDA
XGA-13-19	10/100	1/2" x 3/4"

VÁLVULA DE ESFERA

- De latón.
- Con tuerca loca.
- Para gas.



CLAVE	C/M	MEDIDA
XSB-47-13	12/108	1/2"

VÁLVULA DE GAS

- De latón.
- Mango de aluminio.



CLAVE	C/M	MEDIDA
XLPA-14-10	12/108	3/4" x 1/2"

VÁLVULA DE GAS

- De latón.
- Mango metálico.



CLAVE	C/M	MEDIDA
XLP-06-06	12/108	1/4" x 1/4"

VÁLVULA DE GAS

- De latón.
- Mango metálico.



CLAVE	C/M	MEDIDA
XLP-06-10	12/108	3/8" x 1/4"

VÁLVULA DE GAS

- De latón.
- Mango metálico.



CLAVE	C/M	MEDIDA
XLP-10-10	10/10	3/8" x 3/8"

VÁLVULA DE SEGURIDAD

- De latón.



CLAVE	C/M	MEDIDA
XVA-13-13	12/108	1/2"
XVA-19-19	12/108	3/4"

PIGTAIL

- De 3/8".
- Para gas.
- En aluminio.
- Temp. max.: 40° C.



CLAVE	C/M	MEDIDA
XGF-06-050	10/100	50 cm

MANGUERA PARA USOS GENERALES

- Manguera de NBR.
- Trenzado de acero inoxidable.
- Con tuerca de latón 3/8"
- Inserto de latón.
- Presión max: 1 PSI.
- Temperatura: 60°C

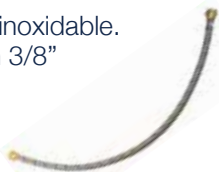

CLAVE	C/M	MEDIDA
XGF-S6-060	10/100	60 cm
XGF-S6-100	10/100	100 cm
XGF-S6-150	10/50	150 cm
XGF-S6-200	10/50	200 cm
XGF-S6-300	10/40	300 cm
XGF-S6-500	10/30	500 cm

MANGUERA PARA USOS GENERALES

- Manguera de NBR.
- Trenzado de vinil.
- Con tuerca de latón 3/8"
- Inserto de latón.
- Presión max: 1 PSI.
- Temperatura: 60°C



CLAVE	C/M	MEDIDA
XGF-V6-060	10/100	60 cm
XGF-V6-100	10/100	100 cm
XGF-V6-150	10/50	150 cm
XGF-V6-200	10/50	200 cm
XGF-V6-300	10/40	300 cm
XGF-V6-500	10/30	500 cm

MANGUERA PARA USOS GENERALES

- De 3/8"
- Trenzado de aluminio.
- Temp. max.: 60° C.



CLAVE	C/M	MEDIDA
XGF-06-060	10/100	60 cm
XGF-06-100	10/100	100 cm
XGF-06-150	10/50	150 cm
XGF-06-200	10/50	200 cm
XGF-06-300	5/40	300 cm
XGF-06-400	1/25	400 cm
XGF-06-500	5/30	500 cm

MANGUERA PARA USOS GENERALES

- De 5/16"
- Manguera NBR
- Trenzado de aluminio
- Con tuerca de latón
- Presión máx. 1PSI
- Temp. max.: 40° C.



CLAVE	C/M	MEDIDA
XGF-06-06M	10/100	60 cm
XGF-06-20M	10/50	200 cm
XGF-06-50M	5/25	500 cm

FLÉXICO

- Para boiler.
- Longitud: 60 cm.



CLAVE	C/M	MEDIDA
XK-13-60HT	5/100	1/2" x 3/4"
XK-19-60HT	5/100	3/4" x 3/4"
XK-13-90HT	5/60	1/2" x 3/4"
XK-14-90HT	5/60	1/2" x 3/4"

CALENTADOR

- Instantáneo.
- De baja presión.
- Para gas LP.
- 4.5 litros.
- 1 servicio.



CLAVE	LITROS
XK-CAL-INS	4.5



TIPO DE GAS



HÁBITOS DE DUCHA



CAPACIDAD DE SERVICIO



VENTAJAS

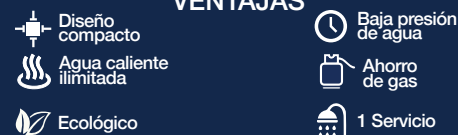

TERMOPAR

- Conexiones de latón.
- Tubo de cobre.

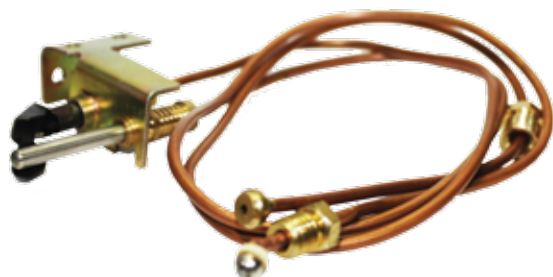

CLAVE	LONGITUD	DIÁMETRO
XTER-PAR	609 mm	3.2 mm

TERMOCOPLE

- Conexiones de latón.
- Tubo de cobre.

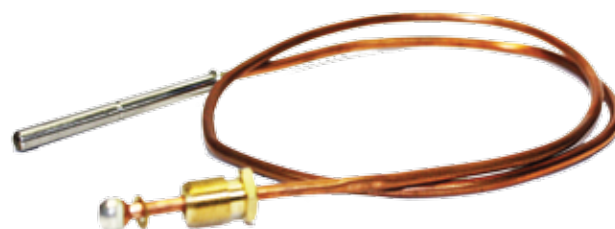

CLAVE	LONGITUD	DIÁMETRO
XTER-COP	609 mm	3.2 mm

alfa green

think green....save water !

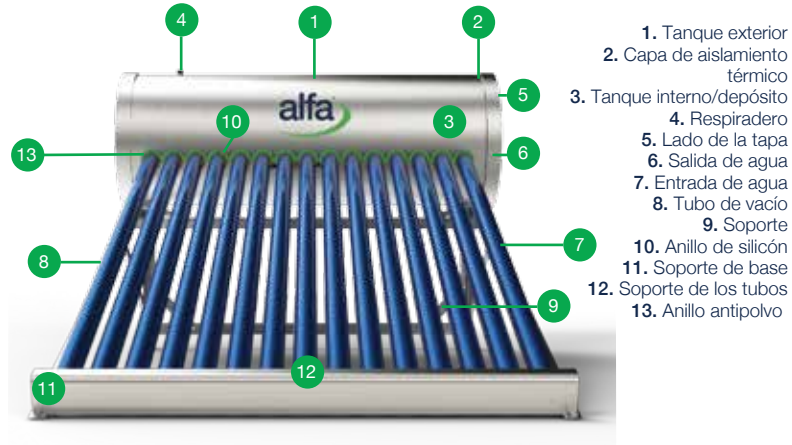

1. Tanque exterior
2. Capa de aislamiento térmico
3. Tanque interno/depósito
4. Respiradero
5. Lado de la tapa
6. Salida de agua
7. Entrada de agua
8. Tubo de vacío
9. Soporte
10. Anillo de silicón
11. Soporte de base
12. Soporte de los tubos
13. Anillo antipolvo



CALENTADOR SOLAR

- Aislante de poliuretano de alta densidad.
- Empaque de silicón para sellado.
- Baja presión.

- El agua caliente se vuelve menos densa y sube al tanque.
- El agua fría que llega al tanque desciende a los tubos

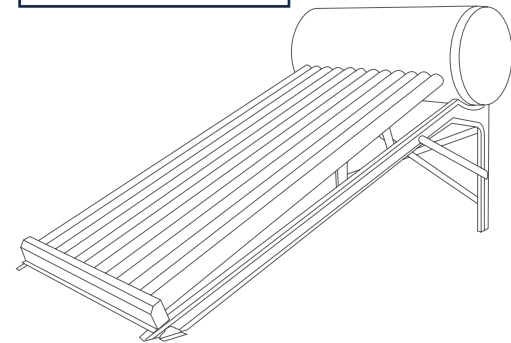

CLAVE	C/M	CAPACIDAD TANQUE	TUBOS	No. PERSONAS	MATERIAL
XK-CALS08	1/1	80 Lts	8	2 - 3	Acero inoxidable
XK-CALS10	1/1	100 Lts	10	3 - 4	Acero inoxidable
XK-CALS12	1/1	120 Lts	12	4 - 5	Acero inoxidable
XK-CALS15	1/1	150 Lts	15	5 - 6	Acero inoxidable
XK-CALS18	1/1	180 Lts	18	7 - 8	Acero inoxidable
XK-CALS20	1/1	200 Lts	20	8 - 9	Acero inoxidable

MÓDULO SOLAR POLICRISTALINO CELDA POLI-CRISTALINA

- Tolerancia de Potencia 0~ +5
- 60 celdas (1640x992x35mm)
- 72 celdas (1960x992x40mm)



*Para cotizar sobre los accesorios y la instalación del sistema (inversores) comuníquese con su ejecutiva de ventas.

CLAVE	C/M	CELDA	No.	PESO	POTENCIA
XS-PAN-265	1/1	60	6 x 10	18.2kg	265-280w
XS-PAN-320	1/1	72	6 x 12	22.6kg	320-335w

INVERSORES

- Soporte de pared.
- Control dinámico de red.
- Entrada con doble MPPT independiente.
- Tensión de entrada de CC máxima 600V.
- Rango de voltaje 180-264V.
- Frecuencia de salida nominal 50/60Hz
- IP65



POTENCIA ENTRADA	VOLTAJE ENTRADA	POTENCIA NOMINAL
2500W	210-53 V	2000W
3500W	170-530 V	3300W
4250W	130-530 V	4000W
4750W	150-530 V	4600W
5150W	145-530 V	5000W
6200W	160-480 V	6000W



COLADERAS

COLADERA DE PISO PARA TUBERÍA

- De una boca.
- Para interiores.
- Rejilla redonda cromada.
- Cuerpo de hierro fundido.



CLAVE	C/M	MEDIDA
XFQ-124	GRANEL	4"

COLADERA DE PISO PARA TUBERÍA

- De tres bocas.
- Para interiores.
- Rejilla redonda cromada.
- Cuerpo de hierro fundido.



CLAVE	C/M	MEDIDA
XFQ-125	GRANEL	4"

COLADERA DE PISO

- De una boca.
- Para interiores.
- Rejilla redonda cromada.
- Cuerpo de hierro fundido.
- Para tubería de 2".



CLAVE	C/M	MEDIDA
XFQ-127	GRANEL	4"

COLADERA

- Tipo granada.
- Para azoteas.
- Rejilla removible.
- Cuerpo de hierro fundido.
- Para tubería de 4".



CLAVE	C/M	MEDIDA
XFQ-444	GRANEL	4"

COLADERA

- De pretil.
- Para azoteas.
- Rejilla removible.
- Para tubería de 4".



CLAVE	C/M	MEDIDA
XFQ-100	GRANEL	4"

COLADERA

- Con rejilla de latón.
- Sistema de control de olores.



CLAVE	C/M	MEDIDA
XFQ-10-LAT	1/50	10 x10 cm

COLADERA

- De acero inoxidable.



CLAVE	C/M	MEDIDA
XFC-10-10	1/50	10 x10 cm

RESUMIDERO

- Cuadrado.
- De hierro.



CLAVE	C/M	MEDIDA
XFQ-10-10	GRANEL	10 x10 cm
XFQ-15-15	GRANEL	15 x 15 cm
XFQ-20-20	GRANEL	20 x 20 cm
XFQ-25-25	GRANEL	25 x 25 cm

REJILLA

- De aluminio.
- De media vuelta.



CLAVE	C/M
XK-10-204U	50/100

COLADERA UNIVERSAL PARA INTERIORES

- Cromada.
- Para tubo de 4", 3" y 2".



CLAVE	C/M
XFQ-01	50/100

COLADERA CUADRADA PARA INTERIORES

- De PVC.
- Cromada.
- Para tubo de 4" y 2".



CLAVE	C/M
XK-15-617	GRANEL

COLADERA

- De PVC.
- Para tubo de 4" y 2".
- Mini.
- Cromada.
- Redonda.



CLAVE	C/M	MEDIDA
XK-15-263	GRANEL	Ø 12.5cm

COLADERA

- De PVC.
- Para tubo de 4" y 2".
- Mini.
- Sin cromar.
- Redonda.



CLAVE	C/M	MEDIDA
XK-15-263S	GRANEL	Ø 12.5cm

COLADERA

- De PVC.
- Para tubo de 2".
- Con salida lateral.
- Rejilla cromada.
- Cuadrada.



CLAVE	C/M	MEDIDA
XK-15-610	GRANEL	16 x 13.5cm

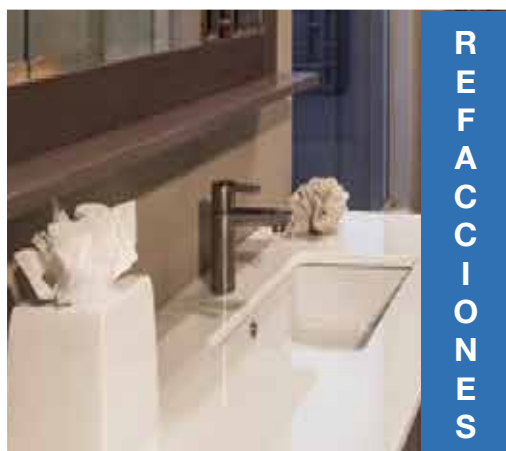

VASTAGO

- 1 pieza.
- De ABS.
- Para mezcladora.



alfa
NUEVO

PROX.
JUL

CLAVE	C/M	MEDIDA
XK-010P	2/200	STD

VASTAGO

- 1 pieza.
- De ABS.
- Para monomando.



alfa
NUEVO

PROX.
JUL

CLAVE	C/M	MEDIDA
XK-MN-V35	1/1	35mm
XK-MN-V40	1/1	40mm

VASTAGO

- Juego de 2 piezas.
- Para válvula de empotrar.
- Cartucho cerámico.



Vuelta de 90°

CLAVE	C/M	MEDIDA
X1-CV	100/500	STD

VASTAGO

- 1 pieza.
- Para mezcladora de fregadero.
- Cartucho cerámico.



Vuelta de 90°

CLAVE	C/M	MEDIDA
XK-NV	50/500	STD

VASTAGO

- Juego de 2 piezas.
- Para mezcladora de lavabo.
- Cartucho cerámico.



Vuelta de 90°

CLAVE	C/M	MEDIDA
X4-CV	25/200	STD

VASTAGO

- Juego de 2 piezas.
- Para mezcladora de lavabo y fregadero.
- De compresión.



Vuelta completa

CLAVE	C/M	MEDIDA
XK-COMP	25/200	4" y 8"

VASTAGO

- 1 pieza.
- Para mezcladora de lavabo.
- Cartucho cerámico.



Vuelta de 90°

CLAVE	C/M	MEDIDA
XK-010R	100/500	STD

VASTAGO

- 1 pieza.
- Para mezcladora de lavabo.
- De compresión.



Vuelta completa

CLAVE	C/M	MEDIDA
XK-002U	40/400	STD

VASTAGO

- 1 pieza.
- Para mezcladora de lavabo.
- De compresión.



Vuelta completa

CLAVE	C/M	MEDIDA
XK-007U	40/400	STD

VASTAGO

- 1 pieza.
- Para llave de empotrar.
- De compresión.



Vuelta completa

CLAVE	C/M	MEDIDA
XK-003U	40/400	STD

VASTAGO

- 1 pieza.
- Para llave de empotrar.
- De compresión.



Vuelta completa

CLAVE	C/M	MEDIDA
XK-008N	50/500	STD

CHAROLA

- De **acero inoxidable**.
- Acabado cromo.



CLAVE	C/M	MEDIDA
XK-MN-LCU	20/200	4"
XK-MN-FCU	1/100	8"

CUELLO

- De **acero inoxidable**.
- Para mezcladora de fregadero.



CLAVE	C/M	TIPO
XK-318-CU	4/400	Ganso

CUELLO

- De **acero inoxidable**.
- Para mezcladora de fregadero.



CLAVE	C/M	TIPO
XK-318-CUC	50/100	Cobra

CUELLO TIPO BAR

- De **acero inoxidable**.
- Para mezcladora de lavabo.



CLAVE	C/M	TIPO
XK-CD4-CU	6/200	Bar

CUELLO

- Para mezcladora de cocina.
- Metálico.



CLAVE	C/M	TIPO
XK-318-CUR	50/100	Curvo



CUELLO

- Para mezcladora de baño.
- Cuerpo de ABS.
- 2 funciones.



CLAVE	C/M	TIPO
XK-317-RES	50/100	Flexible



CUELLO

- Para mezcladora de cocina.
- Cuerpo de ABS.
- 2 funciones.



CLAVE	C/M	TIPO
XK-318-RES	50/100	Flexible



MONEDA

- Para cespól de lavabo.



CLAVE	C/M	MEDIDA
XK-10-MON	10/10	1/2"

AERADOR

- Para mezcladora de fregadero.



CLAVE	C/M	MEDIDA
XK-318-AE	42/5000	STD
XK-318-AEC	40/2000	STD

AERADOR

- Para mezcladora de fregadero.



CLAVE	C/M	MEDIDA
XK-318-AEP	10/10	STD

BRAZO Y CHAPETÓN

- Para regadera.
- Acabado cromo.



CLAVE	C/M	MEDIDA
XK-11-300	10/100	STD

BRAZO Y CHAPETÓN

- Para regadera.
- Acabado cromo.
- De 90°
- 150mm de largo.



CLAVE	C/M	MEDIDA
XK-11-301	10/30	STD

BRAZO

- Para regadera.
- Redondo.



CLAVE	C/M	COLOR	MEDIDA
XK-11-302N	10/40	NEGRO	24x340mm
XK-11-303	10/40	CROMO	24x340mm

BRAZO

- Para regadera.
- Cuadrado.



CLAVE	C/M	COLOR	MEDIDA
XK-11-303N	10/40	NEGRO	320mm
XK-11-302	10/40	CROMO	320mm

MANGUERA

- Para regadera de teléfono.
- De acero **inoxidable 304**.



CLAVE	C/M	MEDIDA
XK-10-RMA	1/100	STD

alfa
NUEVO

PROX.
MAY

TUBO PARA REGADERA

- Curvo.



alfa
NUEVO

PROX.
JUL

CLAVE	C/M	ACABADO	MEDIDA
XK-11-304	1/200	CROMADO	40cm
XK-11-305	1/200	SATINADO	40cm

SOPORTE

- Para lavabo.
- De acero.



alfa
NUEVO

PROX.
MAY

CLAVE	C/M	MEDIDA
XK-LAB-SP	10/30	STD

SOPORTE DE PARED

- De aluminio.
- Para lavabo y ovalin.



CLAVE	C/M	MEDIDA
XK-AL-SP	20/20	8"

COLUMPIO

- De hierro fundido.
- Para válvula de tanque alto.



CLAVE	C/M	MEDIDA
N-04-01	100/1000	STD

TAQUETE

- PE



alfa
NUEVO

PROX.
JUL

CLAVE	BOLSA	MEDIDA
XK-TAQ-06	100pzs	1/4"
XK-TAQ-08	75pzs	5/16"
XK-TAQ-10	50pzs	3/8"

CUBRETALADRO

- De **acero**.
- Cromado.



CLAVE	C/M	MEDIDA
XK-10-CUB	2/500	STD

alfa
NUEVO

PROX.
JUL

MANERAL

- Para llaves de manguera.
- Para válvulas de globo.



CLAVE	C/M	TIPO
G1013-30	100/100	VOLANTE
G4013-30	100/100	CACAHUATE

VÁLVULA

- De latón.
- Para soplete.



CLAVE	C/M	DETALLES
XSO-01-03	12/120	Roscada

VÁLVULA

- De latón.
- Para soplete.
- Con perilla de ajuste.
- No.4



CLAVE	C/M	MEDIDA
XSO-01-07	10/40	160mm

CINTA SELLA ROSCAS

- Grosor: 0.075 mm.
- Densidad: 0.25 gr/cm

ídrop



CLAVE	C/M	MEDIDA
XKZ-13-00	100/1000	1/2" x 260
XKZ-13-520	100/1000	1/2" x 520
XKZ-19-00	100/1000	3/4" x 260
XKZ-19-520	100/1000	3/4" x 520

CINTA SELLA ROSCAS

- De 0.1 mm de grosor.
- Densidad: 0.3g/cm³



CLAVE	C/M	MEDIDA
XKZA-13-26	100/1000	1/2" x 260"
XKZA-13-52	100/1000	1/2" x 520"
XKZA-19-26	100/1000	3/4" x 260"
XKZA-19-52	100/1000	3/4" x 520"

ESPUMA

- De poliuretano.
- Presto Foam.



CLAVE	C/M	MEDIDA
XES-07-300	1/12	300 ml

SILICÓN TRANSPARENTE

- Silicón anti-hongos.



CLAVE	C/M	MEDIDA
XTS-00-070	12/144	70 g
XTS-00-300	24/24	280 ml

SILICÓN BLANCO

- Silicón anti-hongos.



CLAVE	C/M	MEDIDA
XTS-01-070	12/144	70 g
XTS-01-300	24/24	280 ml

PISTOLA CALAFATEADORA

- De resorte.

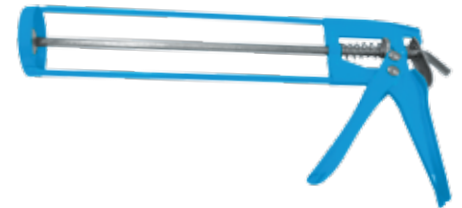

CLAVE	C/M	MEDIDA
XTS-CAL2-R	1/1	STD

PISTOLA CALAFATEADORA

- Con cremallera.



CLAVE	C/M	MEDIDA
XTS-CAL1	1/1	STD

CINTA

- Antiderrapante.
- De seguridad.
- Rollo de 9.15 mts.



CLAVE	C/M	MEDIDA
XCA-25-10	1/12	1"

KIT UNIVERSAL

PARA FABRICA DE HIELO

- Con válvula de apoyo con aguja perforadora de 1/4".
- 6.0 mts. de tubo de polietileno de 1/4".



CLAVE	C/M	MEDIDA
XK-IM-362	1/1	1/4"

KIT UNIVERSAL PARA FABRICA DE HIELO

- Con adaptador para alimentación de agua.
- Con válvula de apoyo tipo silleta de 1/4".
- 6.0 mts. de tubo de polietileno de 1/4".



CLAVE	C/M	MEDIDA
XK-IM-803	1/1	1/4"

LIJA PARA PLOMERO EN ROLLO

- De 45 mts.
- Grano.



CLAVE	C/M	MEDIDA
XK-LJ-1025	1/20	1" x 45m
XK-LJ-1038	1/10	1 1/2" x 45m
XK-LJ-1225	1/20	1" x 45m
XK-LJ-1238	1/10	1 1/2" x 45m

CONECTOR



XK-IM-335



XK-IM-457

CLAVE	C/M	MEDIDA
XK-IM-335	1/1	1/4"
XK-IM-457	1/1	1/4" x 1/4"

ABRAZADERAS

- De acero inoxidable.

CLAVE	No.	DIÁMETRO MÍNIMO	DIÁMETRO MÁXIMO	ANCHO	BOLSA
XKE-08-16	04	3/8"(10mm)	5/8"(16mm)	8mm	100/2000
XKE-08-19	06	1/2"(13mm)	3/4"(20mm)	8mm	100/2000
XKE-13-16	04	3/8"(10mm)	5/8"(16mm)	12.7mm	50/1000
XKE-13-19	06	1/2"(13mm)	3/4"(20mm)	12.7mm	50/1000
XKE-13-22	08	5/8"(16mm)	7/8"(22mm)	12.7mm	50/1000
XKE-13-27	10	3/4"(19mm)	1-1/16"(27mm)	12.7mm	50/1000
XKE-13-32	12	5/8"(16mm)	1-1/4"(32mm)	12.7mm	50/1000
XKE-13-38	16	3/4"(19mm)	1-1/2"(38mm)	12.7mm	50/1000
XKE-13-44	20	3/4"(19mm)	1-3/4"(44mm)	12.7mm	50/1000
XKE-13-51	24	1 1/4"(32mm)	2"(50mm)	12.7mm	50/1000
XKE-13-57	28	1 1/2"(38mm)	2-1/4"(58mm)	12.7mm	50/1000
XKE-13-63	32	1 9/16"(40mm)	2-1/2"(64mm)	12.7mm	50/1000
XKE-13-64	36	1 13/16"(46mm)	2-1/2"(64mm)	12.7mm	50/1000
XKE-13-76	40	2 1/4"(57mm)	3"(76mm)	12.7mm	50/1000



ROTULACIÓN DE FACHADAS

- Logotipo y figuras distintivas de la marca.



*Aplicable para bono

BASE PARA MEZCLADORA Y PARA MONOMANDO



*No incluye producto

CLAVE	C/M
XK-EX-MZ1	1/1
XK-EX-MN1	1/1

EXHIBIDORES DE PISO

Bombas

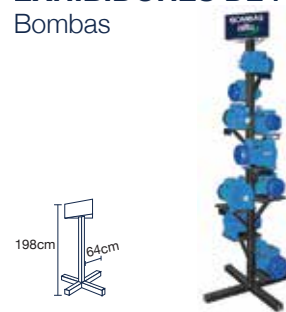

*No incluye producto

CLAVE	MEDIDA
Z-10-BOMB	198 X 64 cm

BOLSA ECOLÓGICA



EXHIBIDORES DE PLACAS Y FOCOS

Productos alfelec



*Las piezas que se indican son por exhibidor

CLAVE	PRODUCTOS
Z-10-PL2	XPL-SS2S•XPL-PL1SIN•XPL-INDIM•XPL-BC2N
Z-10-PL3	XPL-AN1S•XPL-AV2N•XPL-ARTMB•XPL-AB1S1N
Z-10-FOC	COTIZAR

EXHIBIDORES DE PISO

Monomandos
Cespos
Contras
Tarja

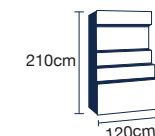

*Las piezas que se indican son por exhibidor

CLAVE	PIEZAS
Z-10-MIX3	15 piezas

EXHIBIDORES DE PISO

Mezcladoras Baño y Cocina
Regaderas y Juego de Baño
Manerales
Monomandos
Tarja

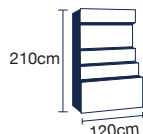

*Las piezas que se indican son por exhibidor

EXHIBIDORES DE PISO

Mezcladoras Baño
Regaderas
Juego de Baño
Manerales
Monomandos

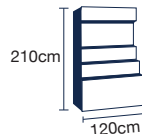

*Las piezas que se indican son por exhibidor

EXHIBIDORES DE PARED

Conexiones de cobre.



*Las piezas que se indican son por exhibidor

CLAVE

Z-10-MIX2

PIEZAS

34 piezas

CLAVE

Z-10-BAN

PIEZAS

34 piezas

CLAVE

Z-10-COBRE

PIEZAS

35 piezas

EXHIBIDORES DE PARED

Conexiones de galvanizado.



*Las piezas que se indican son por exhibidor

EXHIBIDORES DE PARED

Articulos top ALFA.



*Las piezas que se indican son por exhibidor

EXHIBIDORES DE PARED

Conexiones de CPVC.



*Las piezas que se indican son por exhibidor

CLAVE

Z-10-GALV

PIEZAS

35 piezas

CLAVE

Z-10-MIX

PIEZAS

40 piezas

CLAVE

Z-10-CPVC

PIEZAS

42 piezas

EXHIBIDORES DE PARED

Conexiones de PVC Ced. 40.



*Las piezas que se indican son por exhibidor

EXHIBIDORES DE PARED

Conexiones de PVC Ced. 80.



*Las piezas que se indican son por exhibidor

EXHIBIDORES DE PARED

Conexiones de PPR.



*Las piezas que se indican son por exhibidor

CLAVE

Z-10-PVC40

PIEZAS

34 piezas

CLAVE

Z-10-PVC80

PIEZAS

34 piezas

CLAVE

Z-10-PPR

PIEZAS

36 piezas

EXHIBIDORES DE PARED

Fléxicos y Válvulas.

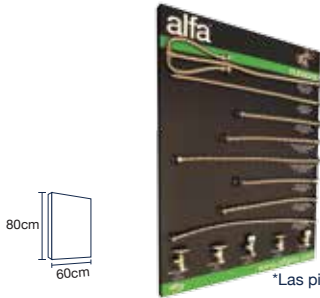

*Las piezas que se indican son por exhibidor

CLAVE	PIEZAS
Z-10-VALFX	13 piezas

DESPACHADOR

- Para mangueras y tubo flexible.
- Capacidad para 3 rollos.
- * Incluye carretes para enrollar.
- * Incluye producto.

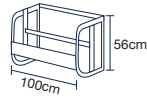

*Las piezas que se indican son por exhibidor

CLAVE	MEDIDA	PIEZAS
Z-10-MANG	100 X 56cm	3 piezas
Z-10-TUB	100 X 56cm	3 piezas

EXHIBIDORES DE PARED

-Artefactos



*Las piezas que se indican son por exhibidor

CLAVE	PIEZAS
Z-10-ART	36 piezas

EXHIBIDORES DE PARED

Placas armadas
- Línea Crystal
Golden Rose

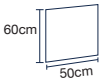

*Las piezas que se indican son por exhibidor

CLAVE	MEDIDA	PIEZAS
Z-10-PLGR	60 X 50 cm	12 piezas

EXHIBIDORES DE PARED

Placas armadas
- Línea Crystal
Mint

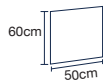

*Las piezas que se indican son por exhibidor

CLAVE	MEDIDA	PIEZAS
Z-10-PLMINT	60 X 50 cm	12 piezas

EXHIBIDORES DE PARED

Placas armadas
- Línea Crystal
Moon Black

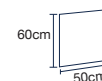

*Las piezas que se indican son por exhibidor

CLAVE	MEDIDA	PIEZAS
Z-10-PLMB	60 X 50 cm	12 piezas

EXHIBIDORES DE PARED

Placas armadas
- Línea Silver
Dark

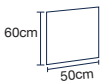

*Las piezas que se indican son por exhibidor

CLAVE	MEDIDA	PIEZAS
Z-10-PLSD	60 X 50 cm	12 piezas

EXHIBIDORES DE PARED

Placas armadas
- Línea Crystal
Natural Snow

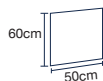

*Las piezas que se indican son por exhibidor

CLAVE	MEDIDA	PIEZAS
Z-10-PLNS	60 X 50 cm	12 piezas

EXHIBIDORES DE PARED

Placas armadas
- Línea
Basic White

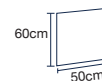

*Las piezas que se indican son por exhibidor

CLAVE	MEDIDA	PIEZAS
Z-10-PLBW	60 X 50 cm	12 piezas

EXHIBIDORES DE PARED

Placas armadas
- Línea Basic
Bianco

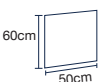

*Las piezas que se indican son por exhibidor

CLAVE	MEDIDA	PIEZAS
Z-10-PLBCO	60 X 50 cm	12 piezas

EXHIBIDORES DE PARED

Placas armadas
- Línea Basic
Madero

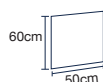

*Las piezas que se indican son por exhibidor

CLAVE	MEDIDA	PIEZAS
Z-10-PLMRO	60 X 50 cm	12 piezas

EXHIBIDORES DE PARED

Placas armadas
- Línea Basic
Griso

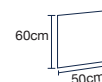

*Las piezas que se indican son por exhibidor

CLAVE	MEDIDA	PIEZAS
Z-10-PLGSO	60 X 50 cm	12 piezas



iDrop[®]

MEZCLADORA PARA LAVABO

- Manerales QUEEN.
- Cuerpo de ABS.



CLAVE C/M MEDIDA

XDRO-Q10CP 1/20 4"

MEZCLADORA PARA LAVABO

- Manerales en acrílico.
- Cuerpo de ABS.



CLAVE C/M MEDIDA

X4-A90-FBL 1/20 4"

MEZCLADORA PARA LAVABO

- Manerales ITALIA.
- Cuerpo plástico/aluminio.



CLAVE C/M MEDIDA

XDROP-4ITA 1/16 4"

MEZCLADORA PARA LAVABO

- Manerales CRUZETA.
- Cuerpo plástico/aluminio.



CLAVE C/M MEDIDA

XDROP-4CRU 1/20 4"

MEZCLADORA PARA LAVABO

- Manerales QUEEN.
- Cuerpo de latón.



CLAVE C/M MEDIDA

XDROP-4QU 1/20 4"

MEZCLADORA PARA LAVABO

- Manerales QUEEN.
- Cuerpo de latón.

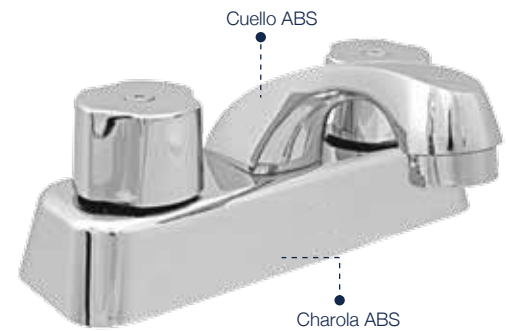

CLAVE C/M MEDIDA

XK-09-046A 20/20 4"

MEZCLADORA PARA LAVABO

- Manerales PALANCA.
- Cuerpo de latón.

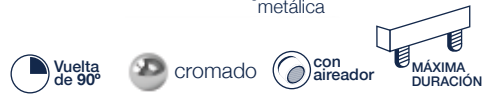
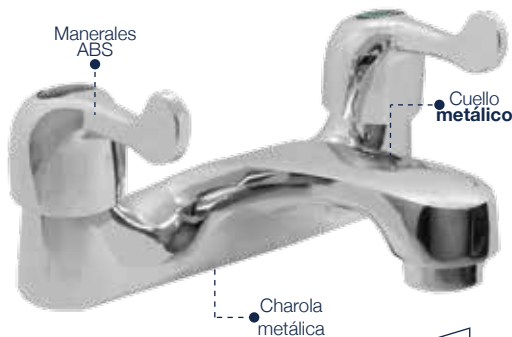

CLAVE C/M MEDIDA

XDROP-4ITZ 1/20 4"

MEZCLADORA PARA FREGADERO

- Manerales QUEEN de ABS.
- Cuerpo plástico/latón.

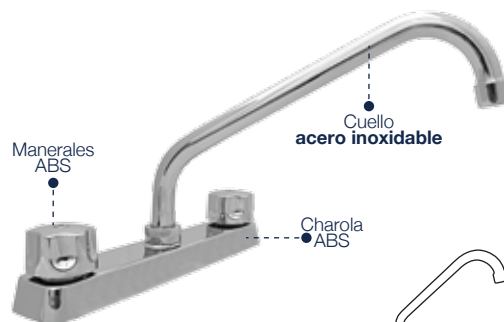

CLAVE C/M MEDIDA

XDRO-9318P 20/20 8"

MEZCLADORA PARA FREGADERO

- Manerales QUEEN de ABS.
- Cuerpo plástico con aluminio color latón.

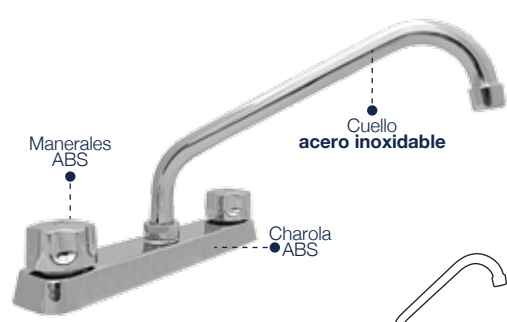

CLAVE C/M MEDIDA

XDROP-8QU 1/20 8"

MEZCLADORA PARA FREGADERO

- Manerales CRUZETA.
- Cuerpo plástico.



CLAVE	C/M	MEDIDA	
XDROP-8CRU	1/20	8"	

MEZCLADORA PARA FREGADERO

- Manerales ITALIA.
- Cuerpo plástico/aluminio.

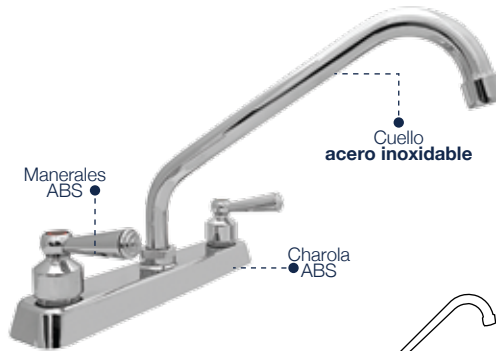

CLAVE	C/M	MEDIDA	
XDROP-8ITA	1/20	8"	

MEZCLADORA PARA FREGADERO

- Manerales PIRULI ABS.
- Cuerpo de ABS.



CLAVE	C/M	MEDIDA	
XK-11-318A	1/16	8"	

LLAVE DE MANGUERA

- De **zinc**.
- Tipo esfera.
- Con conexión estriada.



CLAVE	C/M	MEDIDA
XBG-42-13	12/96	1/2"

LLAVE DE MANGUERA DORADA

- De **zinc**.
- Con rosca en la nariz.



CLAVE	C/M	MEDIDA
XSG-42-13	18/180	1/2"

VÁLVULA PARA PORTA GARRAFÓN



CLAVE	C/M	MEDIDA
XSG-30-13	20/100	1/2"

CINTA SELLA ROSCAS

- Grosor: 0.075 mm.
- Densidad: 0.25 gr/cm



CLAVE	C/M	MEDIDA
XKZ-13-00	100/1000	1/2" x 260
XKZ-13-520	100/1000	1/2" x 520
XKZ-19-00	100/1000	3/4" x 260
XKZ-19-520	100/1000	3/4" x 520

BOMBA PERIFÉRICA

- 120 V / 60 Hz.
- 1" x 1".
- Impulsor de aluminio.
- 3,450 rpm.
- Embobinado de aluminio.



CLAVE	C/M	FLUJO	POTENCIA
XKB-10-13I	1/6	32 lt/min	1/2 hp

BOMBA PERIFÉRICA

- 120 V / 60 Hz.
- 1" x 1".
- Impulsor de aluminio.
- 3,450 rpm.
- Embobinado de aluminio.



CLAVE	C/M	FLUJO	POTENCIA
XKB-10-13R	1/6	32 lt/min	1/2 hp
XKB-10-19R	1/4	32 lt/min	3/4 hp
XKB-10-25R	1/4	32 lt/min	1 hp

NOM



alfaloc®

CERRADURA DE POMO CILÍNDRICA

- Para **entrada**.
- Con cilindro de latón.
- Acabado: latón antiguo.
- Incluye 3 llaves de hierro.

TRES LLAVES DE HIERRO



CLAVE	C/M	ACABADO
QCPC-EAN-3	1/30	LATÓN ANTIGUO

CERRADURA DE POMO CILÍNDRICA

- Para **entrada**.
- Con cilindro de latón.
- Acabado: latón brillante.
- Incluye 3 llaves de hierro.

TRES LLAVES DE HIERRO



CLAVE	C/M	ACABADO
QCPC-ELA-3	1/30	LATÓN BRILLANTE

CERRADURA DE POMO CILÍNDRICA

- Para **entrada**.
- Con cilindro de latón.
- Acabado: acero inoxidable.
- Incluye 3 llaves de latón.

TRES LLAVES DE LATÓN



CLAVE	C/M	ACABADO
QCPC-ESS-3	1/30	ACERO INOX.

CERRADURA DE POMO CILÍNDRICA

- Para **baño**.
- Con cilindro de latón.
- Acabado: latón antiguo.



CLAVE	C/M	ACABADO
QCPC-BAN	1/30	LATÓN ANTIGUO

CERRADURA DE POMO CILÍNDRICA

- Para **baño**.
- Con cilindro de latón.
- Acabado: latón brillante.



CLAVE	C/M	ACABADO
QCPC-BLA	1/30	LATÓN BRILLANTE

CERRADURA DE POMO CILÍNDRICA

- Para **baño**.
- Con cilindro de latón.
- Acabado: acero inoxidable.



CLAVE	C/M	ACABADO
QCPC-BSS	1/30	ACERO INOX.

CERRADURA DE POMO CILÍNDRICA

- Para **recámara**.
- Con cilindro de latón.
- Acabado: latón antiguo.
- Incluye 3 llaves de latón.

TRES LLAVES DE LATÓN



CLAVE	C/M	ACABADO
QCPC-RAN-3	1/30	LATÓN ANTIGUO

CERRADURA DE POMO CILÍNDRICA

- Para **recámara**.
- Con cilindro de latón.
- Acabado: latón brillante.
- Incluye 3 llaves de latón.

TRES LLAVES DE LATÓN



CLAVE	C/M	ACABADO
QCPC-RLA-3	1/30	LATÓN BRILLANTE

CERRADURA DE POMO CILÍNDRICA

- Para **recámara**.
- Con cilindro de latón.
- Acabado: acero inox.
- Incluye 3 llaves de hierro.

TRES LLAVES DE HIERRO



CLAVE	C/M	ACABADO
QCPC-RSS-3	1/30	ACERO INOX.

CERROJO LATÓN ANTIGUO

- Con mariposa.
- Incluye 3 llaves de latón.

TRES LLAVES DE LATÓN



CLAVE	C/M	ACABADO
QCER-AN-3N	1/24	LATÓN ANTIGUO

CERROJO LATÓN

- Con mariposa.
- Incluye 3 llaves de latón.

TRES LLAVES DE LATÓN



CLAVE	C/M	ACABADO
QCER-LA-3N	1/24	LATÓN BRILLANTE

CERROJO ACERO INOXIDABLE

- Con mariposa.
- Incluye 3 llaves de latón.

TRES LLAVES DE LATÓN



CLAVE	C/M	ACABADO
QCER-SS-3N	1/24	ACERO INOX.

CERRADURA DE MANIJA TUBULAR

- Para **entrada**.
- Con cilindro de latón.
- Acabado: acero inoxidable.
- Incluye 3 llaves de hierro.



CLAVE	C/M	ACABADO
QMAT-ESS-3	1/1	ACERO INOX.

CERRADURA DE MANIJA TUBULAR

- Para **baño**.
- Con cilindro de latón.
- Acabado: acero inoxidable.



CLAVE	C/M	ACABADO
QMAT-BSS	1/1	ACERO INOX.

CERRADURA DE MANIJA TUBULAR

- Para **recámara**.
- Con cilindro de latón.
- Acabado: acero inoxidable.
- Incluye 2 llaves de latón.



CLAVE	C/M	ACABADO
QMAT-RSS-2	1/1	ACERO INOX.

MANIJA SATINADA

- Para **baño**.
- Con cilindro de latón.
- Incluye 3 llaves de latón.



CLAVE	C/M	ACABADO
QJAK-BN-ST	1/12	SATINADO

MANIJA SATINADA

- Para **entrada** o **recámara**.
- Con cilindro de latón.
- Incluye 3 llaves de latón.



CLAVE	C/M	ACABADO
QJAK-ET-ST	1/12	SATINADO

MANIJA NEGRA

- Para **entrada**.



CLAVE	C/M	ACABADO
QJAK-ET-NG	1/12	NEGRO



MANIJA CROMADA

- Para **entrada**.



CLAVE	C/M	ACABADO
QJAK-ET-CR	1/12	CROMADO



CERRADURA GATILLO PARA ENTRADA PRINCIPAL

- Con llave tipo Y1.
- De alta seguridad por ámbos lados.
- Para **entrada**.



CLAVE	C/M	ACABADO
QGAT-AN3NL	1/10	LATÓN ANTIGUO

CERRADURA GATILLO PARA ENTRADA PRINCIPAL

- Con llave tipo Y1.
- De alta seguridad por ámbos lados.
- Para **entrada**.



CLAVE	C/M	ACABADO
QGAT-LA3NL	1/10	LATÓN BRILLANTE

CERRADURA GATILLO PARA ENTRADA PRINCIPAL

- Con llave tipo Y1.
- De alta seguridad por ámbos lados.
- Para **entrada**.



CLAVE	C/M	ACABADO
QGAT-SS3NL	1/10	ACERO INOX.

CERRADURA GATILLO PARA ENTRADA PRINCIPAL

- Con llave tipo Y1.
- De alta seguridad por ámbos lados.
- Para **entrada**.



CLAVE	C/M	ACABADO
QGAT-AN3NE	1/10	LATÓN ANTIGUO

CERRADURA GATILLO PARA ENTRADA PRINCIPAL

- Con llave tipo Y1.
- De alta seguridad por ámbos lados.
- Para **entrada**.



TRES LLAVES DE LATÓN TIPO Y1

CLAVE	C/M	ACABADO
QGAT-LA3NE	1/10	LATÓN BRILLANTE

CERRADURA GATILLO PARA ENTRADA PRINCIPAL

- Con llave tipo Y1.
- De alta seguridad por ámbos lados.
- Para **entrada**.



TRES LLAVES DE LATÓN TIPO Y1

CLAVE	C/M	ACABADO
QGAT-SS3NE	1/10	ACERO INOX.

CERRADURA DE SOBREPONER

- Con cilindro de latón.
- Incluye: 3 llaves de latón.

TRES LLAVES DE LATÓN



FÁCIL INSTALACIÓN

CLAVE	C/M	VERSIÓN
QCS-71D3N	1/1	DERECHA
QCS-71I3N	1/1	IZQUIERDA

CERRADURA DE SOBREPONER

- Con cilindro de latón.
- Incluye: 3 llaves de latón.

TRES LLAVES DE LATÓN



FÁCIL INSTALACIÓN

CLAVE	C/M	VERSIÓN
QCS-71DF3N	1/1	DERECHA
QCS-71IF3N	1/1	IZQUIERDA

CERRADURA DE SOBREPONER ALTA SEGURIDAD

- Con cilindro de latón.
- Incluye: 3 llaves de hierro de máxima seguridad.

TRES LLAVES DE PUNTO



FÁCIL INSTALACIÓN

CLAVE	C/M	VERSIÓN
QCS-72D5P	1/24	DERECHA
QCS-72I5P	1/24	IZQUIERDA

CERRADURA DE SOBREPONER ALTA SEGURIDAD

- Con cilindro de latón.
- Incluye: 5 llaves de latón de máxima seguridad.

CINCO LLAVES DE PUNTO



FÁCIL INSTALACIÓN

CLAVE	C/M	VERSIÓN
QCS-72DF5P	1/24	DERECHA
QCS-72IF5P	1/24	IZQUIERDA

CERRADURA DE SOBREPONER MÁXIMA SEGURIDAD

- Con cilindro de latón sólido.
- Barras de acero.
- Incluye: 3 llaves de hierro.



TRES LLAVES DE FIERRO



FÁCIL INSTALACIÓN

PROX. JUL

CLAVE	C/M	VERSIÓN
QCS-DI3P	1/24	IZQUIERDA

CERRADURA PARA PUERTA CORREDIZA

- Con cilindro de latón sólido.
- Acción vertical.
- Incluye: 3 llaves de hierro.



TRES LLAVES DE FIERRO



FÁCIL INSTALACIÓN

PROX. JUL

CLAVE	C/M	VERSIÓN
QCS-IPC-3N	1/24	IZQUIERDA
QCS-DPC-3N	1/24	DERECHA

CERRADURA DE BARRA FIJA

- Con cilindro de latón.
- Incluye dos llaves de latón.

DOS LLAVES DE LATÓN



CLAVE	C/M	VERSIÓN
QCB-DFJ-2N	1/24	DERECHA
QCB-IFJ-2N	1/24	IZQUIERDA

CERRADURA DE BARRA FIJA

- Con cilindro de latón.
- Incluye 3 llaves de latón de máxima seguridad.

TRES LLAVES TIPO TETRA



CLAVE	C/M	VERSIÓN
QCB-DFJ-3T	1/24	DERECHA
QCB-IFJ-3T	1/24	IZQUIERDA

CERRADURA DE BARRA LIBRE

- Con cilindro de latón.
- Incluye 2 llaves de latón.

DOS LLAVES DE LATÓN



CLAVE	C/M	VERSIÓN
QCB-DLB-2N	1/24	DERECHA
QCB-ILB-2N	1/24	IZQUIERDA

BISAGRA

- De acero.
- Dorada.
- Incluye tornillos.



PROX. JUL

CLAVE	C/M	MEDIDA	GROSOR
QBI-L20	1/24	3 X 3	2.0mm
QBI-L22	1/24	3 X 3.5	2.2mm
QBI-L25	1/24	3 X 4	2.5mm

BISAGRA

- De acero.
- Cromada.



CLAVE	C/M	MEDIDA	GROSOR
QBI-C20	1/24	3 X 3	2.0mm
QBI-C22	1/24	3 X 3.5	2.2mm
QBI-C25	1/24	3 X 4	2.5mm

JALADERA DE CAJÓN

- Eclipse.
- De aluminio.



CLAVE	C/M	MEDIDA
JECL-AL128	1/24	128mm
JECL-AL160	1/24	160mm
JECL-AL192	1/24	192mm

JALADERA DE CAJÓN

- Rectangular.
- De aluminio.



CLAVE	C/M	MEDIDA
JREC-AL128	1/24	128mm
JREC-AL160	1/24	160mm
JREC-AL192	1/24	192mm

JALADERA DE CAJÓN

- Arco.
- De aluminio.



CLAVE	C/M	MEDIDA
JARC-AL160	1/24	160mm

CERRADURA DE CAJÓN

- Acción vertical.
- Sistema de llave.
- Cilindro de zinc.
- 2 llaves de hierro.



CLAVE	C/M	ACABADO
QCC-AV-2C	1/24	Cromo

CERRADURA DE CAJÓN

- Acción vertical.
- Sistema de llave.
- Cilindro de zinc.
- 2 llaves de hierro.



CLAVE	C/M	ACABADO
QCC-AV-2L	1/24	Latón

CERRADURA DE CAJÓN

- Acción vertical y horizontal.
- Cilindro de zinc sólido 36mm.



CLAVE	C/M	ACABADO
QCC-AH-2L	1/24	Latón

CERRADURA DE CAJÓN

- Acción vertical y horizontal.
- Cilindro de zinc sólido 36mm.



CLAVE	C/M	ACABADO
QCC-AH-2C	1/24	Cromo

CERRADURA DE CAJÓN

- De botón.
- Cilindro de zinc.
- 2 llaves de hierro.



CLAVE	C/M	ACABADO
QCC-AB-2C	1/24	Cromo

CERRADURA DE CAJÓN

- De botón.
- Cilindro de zinc.
- 2 llaves de hierro.



CLAVE	C/M	ACABADO
QCC-AB-2L	1/24	Latón

TOPE DE PISO PARA PUERTA

- Metálico.
- Tipo domo.



CLAVE	C/M	ACABADO
QTO-DOC	1/24	Cromo

TOPE DE PISO PARA PUERTA

- Metálico.
- Tipo domo.

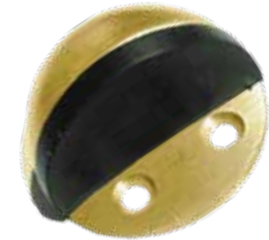

CLAVE	C/M	ACABADO
QTO-DOL	1/24	Latón

TOPE MAGNÉTICO

PARA PUERTA

- Metálico.
- Sistema de imanes.



CLAVE	C/M	ACABADO
QTO-MAL	1/24	Latón Brillante
QTO-MAC	1/24	Cromado

MIRILLA

- Cuerpo de latón.
- Diámetro 14mm.
- Ángulo de visión 180°



CLAVE	C/M	ACABADO
QMIR-14L	1/24	Latón

MIRILLA

- Cuerpo de latón.
- Diámetro 14mm.
- Ángulo de visión 180°



CLAVE	C/M	ACABADO
QMIR-14C	1/24	Cromo

GANCHO DOBLE

- Metálico.
- 7cm.



CLAVE	C/M	ACABADO
QGAN-DBC	1/24	CROMADO
QGAN-DBN	1/24	NIQUELADO

TIPOS DE LLAVE

- LLAVE TRADICIONAL
- LLAVE MULTIPUNTOS
- LLAVE TETRA
- LLAVE TUBULAR

NIVEL DE SEGURIDAD

BÁSICA
Para uso común ligero y cotidiano.

ALTA
Alta protección en interiores y exteriores.

MÁXIMA
Máxima seguridad para áreas industriales y comerciales.

CANDADO DE HIERRO

- Con cilindro de latón.
- Incluye 3 llaves de acero.
- Gancho corto.



CLAVE	MEDIDA	PERNOS
QCAN-IR20	20 MM	3
QCAN-IR25	25 MM	4
QCAN-IR32	32 MM	5
QCAN-IR38	38 MM	5
QCAN-IR63	63 MM	6

CANDADO RECTÁNGULAR DE ACERO

- Con cilindro de latón sólido.
- Incluye 3 llaves de alta seguridad.
- Seguro de balín.
- Alta seguridad.



CLAVE	MEDIDA	PERNOS
QCOR-IR70	70 MM	6
QCOR-IR80	80 MM	6

CANDADO DE LATÓN

- Con cilindro de latón.
- Incluye 3 llaves de latón.
- Gancho corto.



CLAVE	MEDIDA	PERNOS
QCAN-LA20	20 MM	3
QCAN-LA25	25 MM	4
QCAN-LA40	40 MM	5
QCAN-LA50	50 MM	5

CANDADO DE LATÓN

- Con cilindro de latón.
- Incluye 3 llaves de latón.
- Gancho largo.



CLAVE	MEDIDA	PERNOS
QCAN-LA40L	40 MM	5
QCAN-LA50L	50 MM	5
QCAN-LA60L	60 MM	6

CANDADO RECTÁNGULAR DE LATÓN

- Con cilindro de latón.
- Incluye 3 llaves de alta seguridad.
- Seguro de balín.
- Alta seguridad.



CLAVE	MEDIDA	PERNOS
QCOR-LA70	70 MM	6
QCOR-LA80	80 MM	6

CANDADO METÁLICO DE 26 MM

- De 4 pernos.
- Con cilindro de latón.
- Incluye 2 llaves de latón.



CLAVE	C/M	GANCHO
QCAN-15-GC	1/1	CORTO
QCAN-15-GL	1/1	LARGO

CANDADO METÁLICO DE 38 MM

- De 4 pernos.
- Con cilindro de latón.
- Incluye 2 llaves de latón.

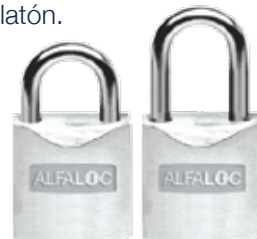

CLAVE	C/M	GANCHO
QCAN-12-GC	1/1	CORTO
QCAN-12-GL	1/1	LARGO

CANDADO METÁLICO DE 45 MM

- De 5 pernos.
- Con cilindro de latón.
- Incluye 2 llaves de latón.

DOS LLAVES DE LATÓN



CLAVE	C/M	GANCHO
QCAN-13-GC	1/1	CORTO
QCAN-13-GL	1/1	LARGO

CANDADO METÁLICO DE 50 MM

- De 5 pernos.
- Con cilindro de latón.
- Incluye 2 llaves de latón.

DOS LLAVES DE LATÓN



CLAVE	C/M	GANCHO
QCAN-14-GC	1/1	CORTO
QCAN-14-GL	1/1	LARGO

CANDADO METAL PULIDO

- Alta seguridad.
- Gancho corto.
- Cilindro metálico.
- Incluye 4 llaves de metal.

CUATRO LLAVES DE METAL



CLAVE	C/M	MEDIDA
QCAN-23-GC	1/72	30 mm
QCAN-24-GC	1/72	40 mm
QCAN-25-GC	1/72	50 mm
QCAN-26-GC	1/72	60 mm

CANDADO LAMINADO LAMINADO

- Con cilindro de latón.
- Incluye 2 llaves de acero.
- Gancho corto.
- Seguro doble tipo perno.

DOS LLAVES DE ACERO



CLAVE	MEDIDA	PERNOS
QCAN-LM30	30 MM	4
QCAN-LM40	40 MM	4
QCAN-LM50	50 MM	4

CANDADO LAMINADO IMPERMEABLE

- Con cilindro de latón.
- Incluye 2 llaves de acero.
- Gancho largo.
- Cubierta de PVC.

DOS LLAVES DE ACERO



CLAVE	MEDIDA	PERNOS
QCAN-LC30	30 MM	4
QCAN-LC40	40 MM	4
QCAN-LC50	50 MM	4
QCAN-LC65	65 MM	5

CANDADO DE COMBINACIÓN DE 50 MM

- De acero.
- Combinación fija de 3 cifras.



CLAVE	C/M	MEDIDA
QCAN-50-CO	1/120	50 mm

CANDADO DE COMBINACIÓN METÁLICO

- Tipo maletero.
- Combinación personalizada 3 dígitos.



CLAVE	MATERIAL
QCAN-CMB	METAL

CANDADO

- De acero.
- Cilindro de latón.
- Incluye 3 llaves de punto.



TRES LLAVES DE PUNTO



CLAVE	MEDIDA	GANCHO
QCAN-GC65	65 MM	CORTO
QCAN-GL65	65 MM	LARGO

CANDADO

- De acero.
- Cilindro de latón.
- Incluye 3 llaves de acero.



TRES LLAVES DE ACERO



CLAVE	MEDIDA
QCAN-GA50	50 MM
QCAN-GA60	60 MM

CANDADO MALETERO TSA DE COMBINACIÓN

- Combinación personalizada 3 dígitos.
- Cuerpo PVC.
- Cumple con la norma TSA de USA.



CLAVE	MATERIAL
QCAN-TSA	PLÁSTICO

CANDADO PARA BICICLETA CON DOS LLAVES

- Cable de acero.
- Cubierta de PVC.

DOS LLAVES



CLAVE	MEDIDA
QCAN-BCI	120 MM/8 MM

CANDADO PARA BICICLETA DE COMBINACIÓN

- Combinación de 4 dígitos.
- Con portacandados.



CLAVE	MEDIDA
QCAN-BC-CO	1.1m x 11 mm





alfelec®



E14



E27

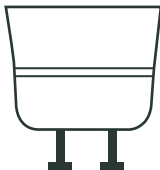

GU10

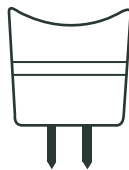

MR16

Tipos de bases



Luz cálida



Luz fría



TIPO DE LUZ QUE UTILIZAS ACTUALMENTE		LÁMPARA LED EQUIVALENTE
Halógeno incandescente	Fluorescente	LED
25W	7W	3W
40W	10W	5W
70W	20W	9W

FOCO LED BULBO

- 127 V
- Para uso en interiores



CLAVE	C/M	TEMP.	WATTS
XBL-3WECO	10/200	6,500K	3W
XBL-5WECO	10/100	6,500K	5W
XBL-7WECO	10/100	6,500K	7W
XBL-9WECO	10/100	6,500K	9W
XBL-12WECO	10/100	6,500K	12W
XBL-15WECO	5/50	6,500K	15W



FOCO LED FILAMENTO VELA

- 127 V
- Para uso en interiores
- 300 lúmenes



CLAVE	C/M	TEMP.	WATTS
XVL-C34W65	24/96	6,500K	4W
XVL-C34W27	24/96	2,700K	4W



FOCO LED FILAMENTO BULBO

- 127 V
- Para uso en interiores
- 400 lúmenes



CLAVE	C/M	TEMP.	WATTS
XBL-E24W65	24/96	6,500K	4W
XBL-E24W27	24/96	2,700K	4W



FOCO LED FILAMENTO BULBO CHICO

- 127 V
- Para uso en interiores
- 300 lúmenes



CLAVE	C/M	TEMP.	WATTS
XGL-G44W65	24/96	6,500K	4W
XGL-G44W27	24/96	2,700K	4W



FOCO LED FILAMENTO BULBO

- Transparente
- 127 V
- Para uso en interiores
- 220 lúmenes

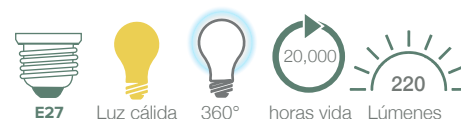

CLAVE	C/M	TEMP.	WATTS
XGT-G42W27	24/96	3,000K	2W



FOCO LED FILAMENTO BULBO

- Mate
- 127 V
- Para uso en interiores
- 200 lúmenes



E27 Luz cálida 360° horas vida 20,000 Lúmenes 200

CLAVE	C/M	TEMP.	WATTS
XGB-G42W27	24/96	● 3,000K	2W



FOCO LED BULBO

- 127 V
- Para uso en interiores
- 1300/1700 lúmenes



CLAVE	C/M	TEMP.	WATTS
XT-0815W65	1/12	● 6,500K	15W
XT-0815W27	1/12	● 2,700K	15W
XT-1017W65	1/12	● 6,500K	17W
XT-1017W27	1/12	● 2,700K	17W



FOCO LED BULBO

- 127 V
- Para uso en interiores
- 2200 lúmenes



E27 Luz de día Luz cálida 160° horas vida 15,000 Lúmenes 2200

CLAVE	C/M	TEMP.	WATTS
XT-1224W65	1/10	● 6,500K	24W
XT-1224W27	1/10	● 2,700K	24W



FOCO LED BULBO

- 127 V
- Para uso en interiores
- 3000 lúmenes



CLAVE	C/M	TEMP.	WATTS
XT-1234W65	1/10	● 6,500K	34W
XT-1234W27	1/10	● 2,700K	34W



FOCO LED BULBO

- 127 V
- Para uso en interiores
- 1050 lúmenes



E27 Luz de día Luz cálida 130° horas vida 15,000 Lúmenes 1050

CLAVE	C/M	TEMP.	WATTS
XA-6512W60	5/50	● 6,500K	12W
XA-6512W27	5/50	● 2,700K	12W



FOCO LED CANDIL

- 127 V
- Para uso en interiores
- 250/410 lúmenes



CLAVE	C/M	TEMP.	WATTS
XC-3703W60	10/100	● 6,500K	3W
XC-3703W27	10/100	● 2,700K	3W
XC-3705W60	10/100	● 6,500K	5W
XC-3705W27	10/100	● 2,700K	5W



FOCO LED BULBO

- 127 V
- Para uso en interiores
- 250/410 lúmenes



E27 Luz de día Luz cálida 130° horas vida 15,000 Lúmenes 250 410

CLAVE	C/M	TEMP.	WATTS	LÚMENES
XG-4503W60	10/100	● 6,500K	3W	250
XG-4503W27	10/100	● 2,700K	3W	250
XG-4505W60	10/100	● 6,500K	5W	410
XG-4505W27	10/100	● 2,700K	5W	410



FOCO LED BULBO

- 127 V
- Para uso en interiores



CLAVE	TEMP.	WATTS	LÚMENES
XFO-B03W65	● 6,500K	3W	250
XFO-B03W27	● 2,700K	3W	250
XA-5605W60	● 6,500K	5W	450
XA-5605W27	● 2,700K	5W	450
XA-6009W60	● 6,500K	9W	810
XA-6009W27	● 2,700K	9W	810



FOCO DICROICO

- 12 V
- Para uso en interiores



CLAVE	TEMP.	WATTS	LÚMENES
XMR-163W60	6,500K	3W	250
XMR-163W27	2,700K	3W	250

FOCO DICROICO

- 12 V
- Para uso en interiores



CLAVE	TEMP.	WATTS	LÚMENES
XMR-164W60	6,500K	4W	400
XMR-164W27	2,700K	4W	400

FOCO DICROICO

- 12 V
- Para uso en interiores



CLAVE	TEMP.	WATTS	LÚMENES
XGU-103W60	6,500K	3W	250
XGU-103W27	2,700K	3W	250

FOCO DICROICO

- 12 V
- Para uso en interiores



CLAVE	TEMP.	WATTS	LÚMENES
XGU-104W60	6,500K	4W	400
XGU-104W27	2,700K	4W	400

FOCO COB

- 127 V
- para uso en interiores



CLAVE	TEMP.	WATTS	LÚMENES
XCB-GU3W65	6,500K	3W	250
XCB-GU3W27	2,700K	3W	250
XCB-GU6W65	6,500K	6W	470
XCB-GU6W27	2,700K	6W	470

FOCO COB

- 127 V
- Para uso en interiores



CLAVE	TEMP.	WATTS	LÚMENES
XCB-MR3W65	6,500K	3W	250
XCB-MR3W27	2,700K	3W	250
XCB-MR6W65	6,500K	6W	470
XCB-MR6W27	2,700K	6W	470

FOCO COB

- 127 V
- Para uso en interiores



CLAVE	TEMP.	WATTS	LÚMENES
XCB-E23W65	6,500K	3W	250
XCB-E23W27	2,700K	3W	250
XCB-E26W65	6,500K	6W	470
XCB-E26W27	2,700K	6W	470

SERIE DE 24 BASES

- Uso interior.
- Con 24 focos.
- 15 m.
- 127 V~



CLAVE	TEMP.	POTENCIA
XLE-24CORD	2,700K	264 W



REFLECTOR

- 127 V
- Uso en interiores



CLAVE	TEMPERATURA	WATTS	LÚMENES
XRF-10WNG	6,500K	10W	550
XRF-20WNG	6,500K	20W	1200

REFLECTOR MODERNO

- 100 V
- Cuerpo de aluminio cubierto de vidrio templado.



CLAVE	WATTS	LÚMENES	LEDS
XRF-10WDM	10W	900	1
XRF-30WDM	30W	2700	1
XRF-50WDM	50W	2700	1
XRF-80WDM	80W	3600	1

LÁMPARA LED

- 100 V
- Cuerpo de policarbonato.
- Reflector de aluminio.



CLAVE	WATTS	MEDIDA	LÚMENES
XLUFO-100W	100W	Ø 230mm	10000

TUBO DE LED

- 85 - 265 V
- 2 polos.
- Cubierta acrílico transparente.



CLAVE	C/M	LONGITUD	WATTS
XT8-69WV2	20	60 cm	9W
XT8-218WV2	20	120 cm	18W

REFLECTOR

- 240 V
- Cuerpo de aluminio cubierto de vidrio templado.



CLAVE	WATTS	LÚMENES	LEDS
XRF-10WGR	10W	900	1
XRF-20WGR	20W	1800	1
XRF-20WGRS	20W	1800	1
XRF-30WGR	30W	2700	1
XRF-50WGR	50W	2700	1
XRF-70WGR	70W	3600	1

REFLECTOR SENSOR DE MOVIMIENTO

- 100 V
- Cuerpo de aluminio cubierto de vidrio templado.

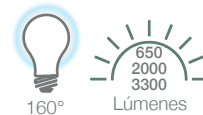

CLAVE	WATTS	LÚMENES	LEDS
XRF-10WDMS	10W	650	1
XRF-30WDMS	30W	2000	1
XRF-50WDMS	50W	3300	1

TUBO DE LED

- 85 - 265 V
- Con base de aluminio.
- 2 polos.
- Cubierta acrílico.



CLAVE	C/M	LONGITUD	WATTS	TEMP.	LÚMENES
XT8-69WP32	30	60 cm	9W	2,700K	855
XT8-218WP2	30	120 cm	18W	6,500K	1530

TUBO DE LED

- 85 - 265 V
- 1 polo.
- Cubierta acrílico transparente.



CLAVE	C/M	LONGITUD	WATTS
XT8-69WV1	30	60 cm	9W
XT8-218WV1	20	120 cm	18W

TUBO DE LED

- 85 - 265 V
- Sin base.
- Tubo de plástico.
- 1 polo.



CLAVE	C/M	LONGITUD	WATTS	LÚMENES
XT8-69WPN	30	60 cm	9W	855
XT8-218WPN	30	120 cm	18W	1530

LUMINARIO LED

- Empotrable
- Para uso en interiores
- 127V



CLAVE	LÚMENES	WATTS	DIÁMETRO
XTE-12W65	800	12 W	30 cm
XTE-18W65	1360	18 W	34 cm
XTE-24W65	1680	24 W	44 cm

LÁMPARA LED TIPO COB

- Cuadrada
- Para uso en interiores
- 127V



CLAVE	DIÁMETRO	MEDIDA	LÚMENES	WATTS
XCB-3W2C	5 cm	7.5 cm	220	3 W
XCB-5W25C	7 cm	9.5 cm	350	5 W
XCB-7W35C	9 cm	12 cm	560	7 W
XCB-12W4C	11 cm	14 cm	960	12 W

LÁMPARA LED TIPO COB

- Redonda
- Para uso en interiores
- 127V



CLAVE	DIÁMETRO INT.	DIÁMETRO EXT.	LÚMENES	WATTS
XCB-3W2R	5 cm	7.5 cm	220	3 W
XCB-5W25R	7 cm	9.5 cm	350	5 W
XCB-7W35R	9 cm	12 cm	560	7 W
XCB-12W4R	11 cm	14 cm	960	12 W

LÁMPARA LED ULTRA DELGADA

- Cuadrada
- Para uso en interiores



CLAVE	A	B	WATTS	TEMP
XEM-CD6W	12 X 12cm	10 X 10cm	6 W	● 6,500K
XEM-CD12W	17 X 17cm	14.02 X 14.02cm	12 W	● 6,500K
XEM-CD18W	22.5 X 22.5cm	19 X 19cm	18 W	● 6,500K

LÁMPARA LED ULTRA DELGADA

- Redonda
- Para uso en interiores



CLAVE	A	B	WATTS	TEMP
XEM-RD6W	Ø 12 cm	Ø 10 cm	6 W	● 6,500K
XEM-RD12W	Ø 17 cm	Ø 14.02 cm	12 W	● 6,500K
XEM-RD18W	Ø 22.5 cm	Ø 19 cm	18 W	● 6,500K

LÁMPARA LED

- Cuadrada
- Para uso en interiores



CLAVE	MEDIDA	LÚMENES	WATTS	TEMPERATURA
XML-CD6W	11 X 11cm	420	6 W	● 6,500K
XML-CD12W	16.5 X 16.5cm	960	12 W	● 6,500K
XML-CD24W	28.5 X 28.5cm	1800	24 W	● 6,500K

LÁMPARA LED

- Redonda
- Para uso en interiores



CLAVE	MEDIDA	LÚMENES	WATTS	TEMPERATURA
XML-RD6W	Ø 11cm	420	6 W	● 6,500K
XML-RD12W	Ø 16.5cm	960	12 W	● 6,500K
XML-RD24W	Ø 28.5cm	1800	24 W	● 6,500K

PLACA ARMADA

Corriente 15 A
Tensión 127 V~

**LÍNEA CRYSTAL
NATURAL SNOW**



CON APAGADOR SENCILLO



CLAVE	C/M
XPL-AB1S	10/100

CON APAGADOR ESCALERA



CLAVE	C/M
XPL-AB1SE	10/100

2 APAGADORES SENCILLOS



CLAVE	C/M
XPL-AB2S	10/100

2 APAGADORES ESCALERA



CLAVE	C/M
XPL-AB2SE	10/100

3 APAGADORES SENCILLOS



CLAVE	C/M
XPL-AB3S	10/100

3 APAGADORES ESCALERA



CLAVE	C/M
XPL-AB3SE	10/100

1 APAGADOR SENCILLO
Y 1 CONTACTO ATERRIZADO



CLAVE	C/M
XPL-AB1S1N	10/100

1 APAGADOR ESCALERA
Y 1 CONTACTO ATERRIZADO



CLAVE	C/M
XPL-AB1E1N	10/100

2 CONTACTOS ATERRIZADOS



CLAVE	C/M
XPL-AB2N	10/100

CON TIMBRE



CLAVE	C/M
XPL-ABTMB	10/100

CON CONECTOR PARA TV



CLAVE	C/M
XPL-ABTV	10/100

CONECTOR PARA TELÉFONO



CLAVE	C/M
XPL-ABTEL	10/100

1 CONTACTO Y 2 ENTRADAS
USB



CLAVE	C/M
XPL-AB2USB	10/100

PLACA ARMADA

Corriente 15 A
Tensión 127 V~

LÍNEA CRYSTAL GOLDEN ROSE



APAGADOR SENCILLO



CLAVE	C/M
XPL-AR1S	10/100

APAGADOR ESCALERA



CLAVE	C/M
XPL-AR1SE	10/100

2 APAGADORES SENCILLOS



CLAVE	C/M
XPL-AR2S	10/100

2 APAGADORES ESCALERA



CLAVE	C/M
XPL-AR2SE	10/100

3 APAGADORES SENCILLOS



CLAVE	C/M
XPL-AR3S	10/100

3 APAGADORES ESCALERA



CLAVE	C/M
XPL-AR3SE	10/100

1 APAGADOR SENCILLO
Y 1 CONTACTO ATERRIZADO



CLAVE	C/M
XPL-AR1S1N	10/100

1 APAGADOR ESCALERA
Y 1 CONTACTO ATERRIZADO



CLAVE	C/M
XPL-AR1E1N	10/100

2 CONTACTOS ATERRIZADOS



CLAVE	C/M
XPL-AR2N	10/100

CON TIMBRE



CLAVE	C/M
XPL-ARTMB	10/100

CON CONECTOR PARA TV



CLAVE	C/M
XPL-ARTV	10/100

CONECTOR PARA TELÉFONO



CLAVE	C/M
XPL-ARTEL	10/100

1 CONTACTO Y 2 ENTRADAS
USB



CLAVE	C/M
XPL-AR2USB	10/100

PLACA ARMADA

Corriente 15 A
Tensión 127 V~

**LÍNEA CRYSTAL
MOON BLACK**



CON APAGADOR SENCILLO



CLAVE	C/M
XPL-AN1S	10/100

CON APAGADOR ESCALERA



CLAVE	C/M
XPL-AN1SE	10/100

2 APAGADORES SENCILLOS



CLAVE	C/M
XPL-AN2S	10/100

2 APAGADORES ESCALERA



CLAVE	C/M
XPL-AN2SE	10/100

3 APAGADORES SENCILLOS



CLAVE	C/M
XPL-AN3S	10/100

3 APAGADORES ESCALERA



CLAVE	C/M
XPL-AN3SE	10/100

1 APAGADOR SENCILLO
Y 1 CONTACTO ATERRIZADO



CLAVE	C/M
XPL-AN1S1N	10/100

1 APAGADOR ESCALERA
Y 1 CONTACTO ATERRIZADO



CLAVE	C/M
XPL-AN1E1N	10/100

2 CONTACTOS ATERRIZADOS



CLAVE	C/M
XPL-AN2N	10/100

CON TIMBRE



CLAVE	C/M
XPL-ANTMB	10/100

CON CONECTOR PARA TV



CLAVE	C/M
XPL-ANTV	10/100

CONECTOR PARA TELÉFONO



CLAVE	C/M
XPL-ANTEL	10/100

1 CONTACTO Y 2 ENTRADAS
USB



CLAVE	C/M
XPL-AN2USB	10/100

PLACA ARMADA

Corriente 15 A
Tensión 127 V~

LÍNEA CRYSTAL MINT



CON APAGADOR SENCILLO



CLAVE	C/M
XPL-AV1S	10/100

CON APAGADOR ESCALERA



CLAVE	C/M
XPL-AV1SE	10/100

2 APAGADORES SENCILLOS



CLAVE	C/M
XPL-AV2S	10/100

2 APAGADORES ESCALERA



CLAVE	C/M
XPL-AV2SE	10/100

3 APAGADORES SENCILLOS



CLAVE	C/M
XPL-AV3S	10/100

3 APAGADORES ESCALERA



CLAVE	C/M
XPL-AV3SE	10/100

1 APAGADOR SENCILLO
Y 1 CONTACTO ATERRIZADO



CLAVE	C/M
XPL-AV1S1N	10/100

1 APAGADOR ESCALERA
Y 1 CONTACTO ATERRIZADO



CLAVE	C/M
XPL-AV1E1N	10/100

2 CONTACTOS ATERRIZADOS



CLAVE	C/M
XPL-AV2N	10/100

CON TIMBRE



CLAVE	C/M
XPL-AVTMB	10/100

CON CONECTOR PARA TV



CLAVE	C/M
XPL-AVTV	10/100

CONECTOR PARA TELÉFONO



CLAVE	C/M
XPL-AVTEL	10/100

1 CONTACTO Y 2 ENTRADAS
USB



CLAVE	C/M
XPL-AV2USB	10/100

PLACA ARMADA

Corriente 15 A
Tensión 127 V~

**LÍNEA
SILVER DARK**



CON APAGADOR SENCILLO



CLAVE	C/M
XPL-SS1S	10/100

CON APAGADOR ESCALERA



CLAVE	C/M
XPL-SS1SE	10/100

2 APAGADORES SENCILLOS



CLAVE	C/M
XPL-SS2S	10/100

2 APAGADORES ESCALERA



CLAVE	C/M
XPL-SS2SE	10/100

3 APAGADORES SENCILLOS



CLAVE	C/M
XPL-SS3S	10/100

3 APAGADORES ESCALERA



CLAVE	C/M
XPL-SS3SE	10/100

1 APAGADOR SENCILLO
Y 1 CONTACTO ATERRIZADO



CLAVE	C/M
XPL-SS1S1N	10/100

1 APAGADOR ESCALERA
Y 1 CONTACTO ATERRIZADO



CLAVE	C/M
XPL-SS1E1N	10/100

2 CONTACTOS ATERRIZADOS



CLAVE	C/M
XPL-SS2N	10/100

CON TIMBRE



CLAVE	C/M
XPL-SSTMB	10/100

CON CONECTOR PARA TV



CLAVE	C/M
XPL-SSTV	10/100

CONECTOR PARA TELÉFONO



CLAVE	C/M
XPL-SSTEL	10/100

1 CONTACTO Y 2 ENTRADAS
USB



CLAVE	C/M
XPL-SS2USB	10/100

PLACA ARMADA

Corriente 15 A

Tensión 127 V~

LÍNEA BASIC WHITE



CON APAGADOR SENCILLO



CLAVE	C/M
XPL-PL1S	10/100

CON APAGADOR ESCALERA



CLAVE	C/M
XPL-PL1SE	10/100

2 APAGADORES SENCILLOS



CLAVE	C/M
XPL-PL2S	10/100

2 APAGADORES ESCALERA



CLAVE	C/M
XPL-PL2SE	10/100

3 APAGADORES SENCILLOS



CLAVE	C/M
XPL-PL3S	10/100

3 APAGADORES ESCALERA



CLAVE	C/M
XPL-PL3SE	10/100

1 APAGADOR SENCILLO Y 1 CONTACTO ATERRIZADO



CLAVE	C/M
XPL-PL1S1N	10/100

1 APAGADOR ESCALERA Y 1 CONTACTO ATERRIZADO



CLAVE	C/M
XPL-PL1E1N	10/100

2 CONTACTOS ATERRIZADOS



CLAVE	C/M
XPL-PL2N	10/100

CON TIMBRE



CLAVE	C/M
XPL-PLTMB	10/100

CON CONECTOR PARA TV



CLAVE	C/M
XPL-PLTV	10/100

CONECTOR PARA TELÉFONO



CLAVE	C/M
XPL-PLTEL	10/100

1 CONTACTO Y 2 ENTRADAS USB



CLAVE	C/M
XPL-PL2USB	10/100

PLACA ARMADA

Corriente 15 A
Tensión 127 V~

LÍNEA GRISO



CON APAGADOR SENCILLO



CLAVE C/M
XPL-IN1S 10/100

CON APAGADOR ESCALERA



CLAVE C/M
XPL-IN1SE 10/100

2 APAGADORES SENCILLOS



CLAVE C/M
XPL-IN2S 10/100

2 APAGADORES ESCALERA



CLAVE C/M
XPL-IN2SE 10/100

3 APAGADORES SENCILLOS



CLAVE C/M
XPL-IN3S 10/100

3 APAGADORES ESCALERA



CLAVE C/M
XPL-IN3SE 10/100

1 APAGADOR SENCILLO Y 1 CONTACTO ATERRIZADO



CLAVE C/M
XPL-IN1S1N 10/100

CONTACTO ATERRIZADO Y 1 APAGADOR ESCALERA



CLAVE C/M
XPL-IN1E1N 10/100

2 CONTACTOS ATERRIZADOS



CLAVE C/M
XPL-IN2N 10/100

CONECTOR PARA TV



CLAVE C/M
XPL-INTV 10/100

DIMMER



CLAVE C/M
XPL-INDIM 10/100

CONECTOR PARA TELÉFONO



CLAVE C/M
XPL-INTE 10/100

CON TIMBRE



CLAVE C/M
XPL-INTMB 10/100

1 CONTACTO Y 2 ENTRADAS USB



CLAVE C/M
XPL-IN2USB 10/100

PLACA ARMADA

Corriente 15 A
Tensión 127 V~

LÍNEA MADERO



APAGADOR SENCILLO



CLAVE	C/M
XPL-MD1S	10/100

1 APAGADOR DE ESCALERA



CLAVE	C/M
XPL-MD1SE	10/100

2 APAGADORES SENCILLOS



CLAVE	C/M
XPL-MD2S	10/100

2 APAGADORES ESCALERA



CLAVE	C/M
XPL-MD2SE	10/100

3 APAGADORES SENCILLOS



CLAVE	C/M
XPL-MD3S	10/100

2 APAGADORES SENCILLOS Y 1 CONTACTO ESCALERA



CLAVE	C/M
XPL-MD3SE	10/100

CON 2 CONTACTOS



CLAVE	C/M
XPL-MD2N	10/100

1 APAGADOR Y 1 CONTACTO



CLAVE	C/M
XPL-MD1S1N	10/100

1 APAGADOR ESCALERA Y 1 CONTACTO



CLAVE	C/M
XPL-MD1E1N	10/100

CONECTOR PARA TELÉFONO



CLAVE	C/M
XPL-MDTE	10/100

CONECTOR PARA TV



CLAVE	C/M
XPL-MDTV	10/100

CONECTOR PARA TV Y TELÉFONO



CLAVE	C/M
XPL-MDTVTE	10/100

PLACA ARMADA

Corriente 15A
Tensión 127 V~

LÍNEA BIANCO



APAGADOR SENCILLO



CLAVE C/M
XPL-BC1S 10/100

APAGADOR DE ESCALERA



CLAVE C/M
XPL-BC1SE 10/100

2 APAGADORES SENCILLOS



CLAVE C/M
XPL-BC2S 10/100

2 APAGADORES ESCALERA



CLAVE C/M
XPL-BC2SE 10/100

3 APAGADORES SENCILLOS



CLAVE C/M
XPL-BC3S 10/100

3 APAGADORES ESCALERA



CLAVE C/M
XPL-BC3SE 10/100

1 APAGADOR SENCILLO Y 1 CONTACTO ATERRIZADO



CLAVE C/M
XPL-BC1S1N 10/100

2 CONTACTOS ATERRIZADOS



CLAVE C/M
XPL-BC2N 10/100

CON TIMBRE



CLAVE C/M
XPL-BCTMB 10/100

CONECTOR PARA TV



CLAVE C/M
XPL-BCTV 10/100

CONECTOR PARA TELÉFONO



CLAVE C/M
XPL-BCTEL 10/100

CONECTOR PARA TV Y TELÉFONO



CLAVE C/M
XPL-BCTVTE 10/100



Artefactos

PORTALÁMPARA DE PORCELANA TIPO NIPLE

- Soporta temperaturas elevadas (hasta 350°)
- E27



CLAVE	CORRIENTE	TENSIÓN
XA-PO-LA	4A	125 V

PORTALÁMPARA DE PVC

- Para intemperie.
- CABLE:
- Calibre: 18 AWG
- Espesor: 0.83 mm²



CLAVE	CONSUMO	TENSIÓN
XA-PO-LAEX	660 W	127 V

PORTALÁMPARA DE PORCELANA SOPORTE TIPO ESCUADRA

- Soporta temperaturas elevadas (hasta 350°)
- E27

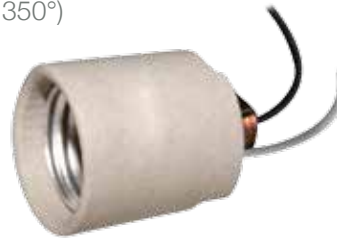

CLAVE	CORRIENTE	TENSIÓN
XA-PO-BLES	4A	125 V

PORTALÁMPARA DE PORCELANA PARA GU10

- Gran resistencia.



CLAVE	CORRIENTE	TENSIÓN
XPOR-GU10	4A	125V

PORTALÁMPARA DE PORCELANA PARA MR16

- Gran resistencia.



CLAVE	CORRIENTE	TENSIÓN
XPOR-MR16	4A	125V

PORTALÁMPARA BASE G13 BIPIN

- Para tubo fluorescente.



CLAVE	CORRIENTE	TENSIÓN
XA-POR-TUB	4A	125V

PORTALÁMPARA DE BAQUELITA CON ADAPTADOR

- Con adaptador tipo clavija.
- E27



CLAVE	CORRIENTE	TENSIÓN
XA-PO-EN	4A	125V

PORTALÁMPARA DE PORCELANA PARA CANDIL

- De sobreponer.
- Soporta temperaturas elevadas (hasta 350°)
- E12



CLAVE	CORRIENTE	TENSIÓN
XA-PO-CAN	4A	125 V

PORTALÁMPARA DE PORCELANA CUADRADO

- De sobreponer.
- Soporta temperaturas elevadas (hasta 350°)
- E27



CLAVE	CORRIENTE	TENSIÓN
XA-PO-TCVC	4A	120 V

PORTALÁMPARA DE PORCELANA CIRCULAR

- De sobreponer.
- Soporta temperaturas elevadas (hasta 350°)
- Diámetro 3 1/2"
- E27



CLAVE	CORRIENTE	TENSIÓN
XA-PB-TRDC	4A	120 V

PORTALÁMPARA DE PORCELANA CIRCULAR

- De sobreponer.
- Soporta temperaturas elevadas (hasta 350°)
- Diámetro 4 1/2"
- E27



CLAVE	CORRIENTE	TENSIÓN
XA-PB-TRDG	4A	120V

PORTALÁMPARA DE BAQUELITA

- De sobreponer.
- Diámetro 3 1/2"
- E27



CLAVE	CORRIENTE	TENSIÓN
XA-PM-TRDC	4A	250V

PORTALÁMPARA DE BAQUELITA SENCILLO

- Rosca integrada al cuerpo.
- E27



CLAVE	CORRIENTE	TENSIÓN
XA-PO-LMEC	4A	125V

PORTALÁMPARA IRROMPIBLE SENCILLO

- Policarbonato de gran resistencia a impactos.
- Rosca integrada al cuerpo.
- E27



CLAVE	CORRIENTE	TENSIÓN
XA-PO-LAM	4A	125V

PORTALÁMPARA DE BAQUELITA CON INTERRUPTOR DE BARRA

- Rosca integrada al cuerpo.
- E27



CLAVE	CORRIENTE	TENSIÓN
XA-PO-LMIN	4A	125V

PORTALÁMPARA DE BAQUELITA CON INTERRUPTOR DE CADENA

- Rosca integrada al cuerpo.



CLAVE	CORRIENTE	TENSIÓN
XA-PO-CAD	4A	125V

PORTALÁMPARA DE BAQUELITA DOBLE CONTACTO (LADRÓN)

- Contactos polarizados.
- E27



CLAVE	CORRIENTE	TENSIÓN
XA-PO-LACC	4A	125V

PORTALÁMPARA DE BAQUELITA CADENA Y DOBLE CONTACTO (LADRÓN)

- Contactos polarizados.
- E27



CLAVE	CORRIENTE	TENSIÓN
XA-PO-LACD	4A	125V

CONTACTO DE SOBREPONER DUPLEX 2 POLOS + TIERRA

- Baquelita.
- Incluye tapa trasera.



CLAVE	CORRIENTE	TENSIÓN
XA-CON-2TE	15A	125V

INTERRUPTOR VERTICAL

- Fabricado en nylon-policarbonato.



CLAVE	CORRIENTE	TENSIÓN
XA-INP-2V	15A	120V

CONTACTO DÚPLEX 2 POLOS, 3 HILOS

- Fabricado en nylon-policarbonato.



CLAVE	CORRIENTE	TENSIÓN
XA-COP-2T2	20A	125V

INTERRUPTOR DÚPLEX

- Fabricado en nylon-policarbonato.



CLAVE	CORRIENTE	TENSIÓN
XA-INP-2E	15A	120V

INTERRUPTOR - CONTACTO

- Fabricado en nylon-policarbonato.



CLAVE	CORRIENTE	TENSIÓN
XA-IN/C-3E	15A	120-125V

INTERRUPTOR DE SOBREPONER SENCILLO

- Baquelita.



CLAVE	CORRIENTE	TENSIÓN
XA-INT-1BT	4A	125V

PLACA DÚPLEX DE ALUMINIO



CLAVE	COLOR	ESPESOR
XA-PL-C2	ORO	0.7 mm

PLACA DE 3 MÓDULOS DE ALUMINIO

- Incluye chasis.
- Fabricado en aluminio anodizado.



CLAVE	COLOR	ESPESOR
XA-PL-3MOD	ORO	0.7 mm

PLACA PARA CONTACTO REDONDO PARA INTEMPERIE

- De policarbonato.



CLAVE	COLOR	DETALLES
XA-PL-IN1M	GRIS	1 VENTANA

PLACA DÚPLEX PARA INTEMPERIE

- De policarbonato.



CLAVE	COLOR	DETALLES
XA-PL-IN2M	GRIS	2 VENTANAS

CHALUPA PVC



CLAVE	COLOR	MEDIDA
XCHA-25-12	NARANJA	11 X 70 X 50mm

CHALUPA PP



CLAVE	COLOR	MEDIDA
XCHA-10-55	NARANJA	105 X 60 X 45mm

CHALUPA METÁLICA

- Profundidad: 1- 7/8"



CLAVE	ESPESOR	MEDIDA
XCHM-25-12	1.0 mm	2 X 4"

CENTRO DE CARGA DE SOBREPONER

- 50 A
- 60 Hz
- 120 - 240 V~



CLAVE	DETALLES	MATERIAL
XCNCA-2VI	2 UNIDADES	ALUMINIO

CENTRO DE CARGA DE SOBREPONER

- 100 A
- 60 Hz
- 120 - 240 V~



CLAVE	DETALLES	MATERIAL
XCNCA-4VI	4 UNIDADES	ALUMINIO

CLAVIJA REFORZADA

- Con abrazadera.
- ABS y PVC.
- Para extensiones y conexiones de aparatos.
- Sin tierra.



CLAVE	CORRIENTE	TENSIÓN
XA-CLA-NGO	15A	125V

CONTACTO REFORZADO

- Con abrazadera.
- ABS y PVC.
- Para extensiones y conexiones de aparatos.
- Sin tierra.



CLAVE	CORRIENTE	TENSIÓN
XA-CON-NGH	15A	125V

CLAVIJA REFORZADA

- Con abrazadera.
- ABS y PVC.
- Para extensiones y conexiones de aparatos.
- Con tierra.



CLAVE	CORRIENTE	TENSIÓN
XA-CLA-NG3	15A	125V

CONTACTO REFORZADO

- Con abrazadera.
- ABS y PVC.
- Para extensiones y conexiones de aparatos.
- Con tierra.



CLAVE	CORRIENTE	TENSIÓN
XA-CON-NTH	15A	125V

CLAVIJA BLINDADA

- Con abrazadera.
- ABS y acero.
- Para extensiones y conexiones de aparatos.
- Sin tierra.



CLAVE	CORRIENTE	TENSIÓN
XA-CLA-PLA	15A	125V

CONTACTO BLINDADO

- Con abrazadera.
- ABS y acero.
- Para extensiones y conexiones de aparatos.
- Sin tierra.



CLAVE	CORRIENTE	TENSIÓN
XA-CON-PLH	15A	125V

CLAVIJA BLINDADA

- Con abrazadera.
- ABS y acero.
- Para extensiones y conexiones de aparatos.
- Con tierra.



CLAVE	CORRIENTE	TENSIÓN
XA-CLA-PL3	15A	125V

CONTACTO BLINDADO

- Con abrazadera.
- ABS y acero.
- Para extensiones y conexiones de aparatos.
- Con tierra.



CLAVE	CORRIENTE	TENSIÓN
XA-CON-PTH	15A	125V

CLAVIJA DE HULE

- PVC.
- Para extensiones y conexiones de aparatos.



CLAVE	CORRIENTE	TENSIÓN
XA-CLA-OVA	15A	120V

ADAPTADOR 3 A 2

- ABS / PVC.
- Convertidores a tierra de uso rudo.



CLAVE	CORRIENTE	TENSIÓN
XA-ADA-3	15A	125V

CLAVIJA PLANA

- ABS.
- Ideal para extensiones y conexiones de aparatos.



CLAVE	CORRIENTE	TENSIÓN
XA-CLA-ECO	10A	127V

CLAVIJA REDONDA DE HULE

- PVC.
- Para extensiones y conexiones de aparatos.



CLAVE	CORRIENTE	TENSIÓN
XA-CLA-RED	15A	127V

CINTA DE AISLAR

- Flexible para cubrir superficies irregulares.
- Espesor: 0.13 mm.
- Elongación: 200 %



CLAVE	C/M	MEDIDA
XK-AS-0919	10/500	9m X 19 mm
XK-AS-1819	10/200	18m X 19 mm

MULTICONTACTO TRIPLE TIPO BISAGRA

- ABS / PVC.
- Polarizado.



CLAVE	CORRIENTE	TENSIÓN
XA-MC-3HE	15A	125V

MULTICONTACTO TRIPLE TIPO BISAGRA ENTRADAS LATERALES

- ABS / PVC.
- Polarizado.



CLAVE	CORRIENTE	TENSIÓN
XA-MC-3E	15A	125V

MULTICONTACTO CUADRADO 2 POLOS + TIERRA, 6 ENTRADAS

- ABS / PVC.
- Aterrizado.
- Para contactos dúplex.



CLAVE	CORRIENTE	TENSIÓN
XA-MC-6T	15A	125V

CINCHOS PLÁSTICOS

● Negro



CLAVE	PIEZAS	MEDIDA
XCN-1025N	100	100 X 2.5
XCN-1525N	100	150 X 2.5
XCN-1535N	50	150 X 3.5
XCN-2025N	100	200 X 2.5
XCN-2035N	50	200 X 3.5
XCN-2045N	50	200 X 4.5
XCN-2535N	50	250 X 3.5
XCN-2545N	50	250 X 4.5
XCN-3045N	50	300 X 4.5
XCN-3545N	25	350 X 4.5
XCN-4045N	25	400 X 4.5
XCN-5045N	25	500 X 4.5
XCN-6045N	25	600 X 4.5

CINCHOS PLÁSTICOS

● Transparente



CLAVE	PIEZAS	MEDIDA
XCN-1025T	100	100 X 2.5
XCN-1525T	100	150 X 2.5
XCN-1535T	50	150 X 3.5
XCN-2025T	100	200 X 2.5
XCN-2035T	50	200 X 3.5
XCN-2045T	50	200 X 4.5
XCN-2535T	50	250 X 3.5
XCN-2545T	50	250 X 4.5
XCN-3045T	50	300 X 4.5
XCN-3545T	25	350 X 4.5
XCN-4045T	25	400 X 4.5
XCN-5045T	25	500 X 4.5
XCN-6045T	25	600 X 4.5

CINCHOS PLÁSTICOS

- Seguro automático.
- En blister.

● Transparente



CLAVE	PIEZAS	COLOR
XCN-BL75T	75	TRANSPARENTE

CINCHOS PLÁSTICOS

- Seguro automático.
- En bote.
- Diferentes colores.



CLAVE	PIEZAS	COLOR
XCN-BT650	650	VARIOS

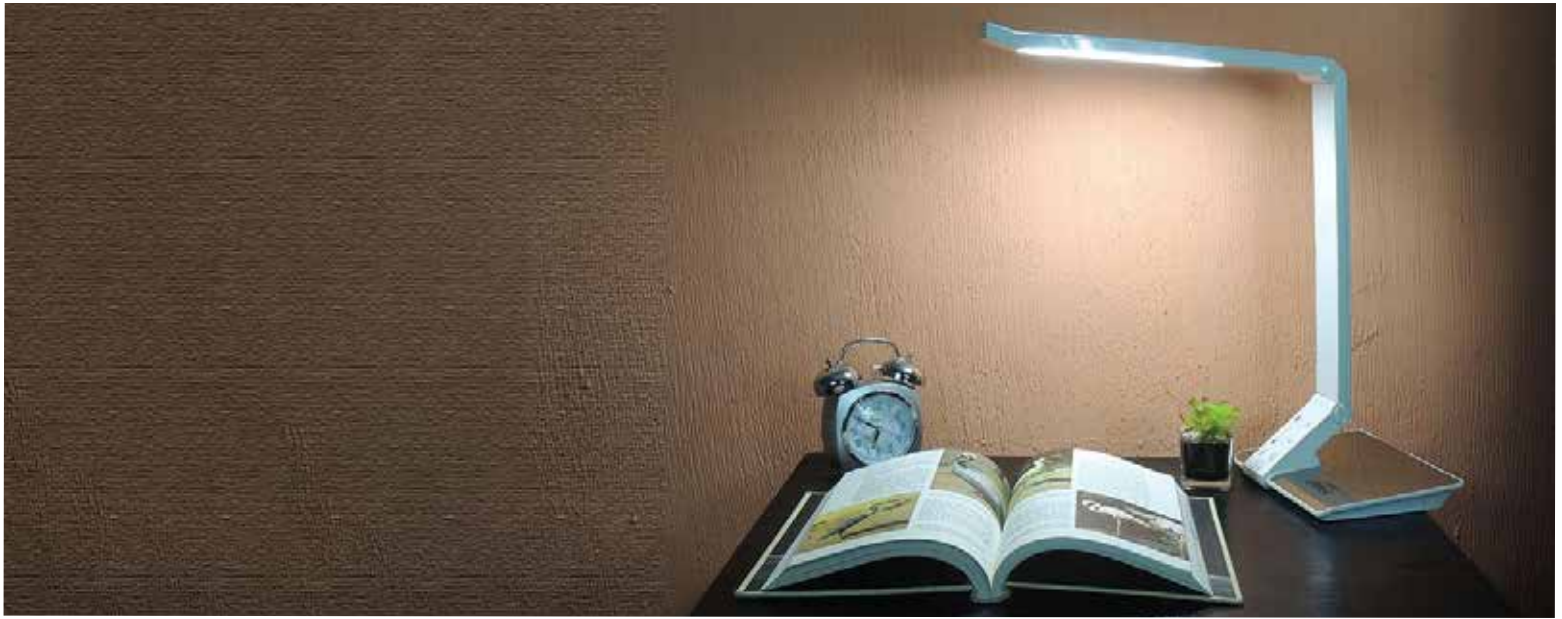

LINTERNAS RECARGABLES

- Cuerpo de ABS.
- Gran resistencia al impacto.
- Se conecta directamente a la corriente eléctrica.
- 7 y 5 leds.



CLAVE	LÚMENES	DURACIÓN	WATTS
SJ-8720	16	6 hrs.	4 W
SJ-8706	28	6 hrs.	7 W
SJ-8721	60	6 hrs.	15W

LINTERNA RECARGABLE

- Cuerpo de ABS.
- Gran resistencia al impacto.
- Se conecta directamente a la corriente eléctrica.
- 4 leds.



CLAVE	LÚMENES	DURACIÓN	WATTS
MK-7005	40	6 hrs.	1 W

LINTERNA RECARGABLE

- Cuerpo de ABS.
- Gran resistencia al impacto.
- Se conecta directamente a la corriente eléctrica.



CLAVE	LÚMENES	DURACIÓN	WATTS
SJ-8306	12	10 hrs.	3 W
SJ-8307	16	10 hrs.	4 W

LÁMPARA DE ESCRITORIO

- Tipo LED.
- Sensor de toque.
- Con 3 tipos de luz.



CLAVE	WATTS	COLOR
XES-ART10W	10	BLANCO

LÁMPARA DE ESCRITORIO

- Tipo LED.
- Sensor de toque.
- Con 3 tipos de luz.
- Con base.



LÁMPARA DE ESCRITORIO

- Tipo LED.
- Sensor de toque.
- Con 3 tipos de luz.
- Con clip.



CLAVE
XES-BAS10W

WATTS
10

COLOR
NEGRO

CLAVE
XES-CLP10W

WATTS
10

COLOR
NEGRO

LÁMPARA DE ESCRITORIO

- Figura balón.
- Flexible.
- Luz incandescente.
- No incluye foco.
- E27



CLAVE
XLA-BL-NG

TENSIÓN
127V

WATTS
40 W

COLOR
BCO/NGO

LÁMPARA DE ESCRITORIO

- Figura balón.
- Flexible.
- Luz incandescente.
- No incluye foco.
- E27



CLAVE
XLA-BL-AZ

TENSIÓN
127V

WATTS
40 W

COLOR
AZUL/BCO

LÁMPARA DE ESCRITORIO

- Figura duende.
- Flexible.
- Luz incandescente.
- No incluye foco.
- E27



CLAVE
XLA-DU-AZ

TENSIÓN
127V

WATTS
40 W

COLOR
BCO/AZUL

LÁMPARA DE ESCRITORIO

- Figura duende.
- Flexible.
- Luz incandescente.
- No incluye foco.
- E27



CLAVE
XLA-DU-VE

TENSIÓN
127V

WATTS
40 W

COLOR
VDE/BCO

LÁMPARA DE ESCRITORIO

- Figura carro.
- Flexible.
- Luz incandescente.
- No incluye foco.
- E27



CLAVE	TENSIÓN	WATTS	COLOR
XLA-CO-RJ	127V	40 W	ROJO

LÁMPARA DE ESCRITORIO

- Figura carro.
- Flexible.
- Luz incandescente.
- No incluye foco.
- E27



CLAVE	TENSIÓN	WATTS	COLOR
XLA-CO-AM	127V	40 W	AMARILLO

LÁMPARA DE ESCRITORIO

- Flexible.
- Luz incandescente.
- No incluye foco.
- E27



CLAVE	TENSIÓN	WATTS	COLOR
XLA-ES-NG	127V	40 W	NEGRO

LÁMPARA DE ESCRITORIO

- Flexible.
- Luz incandescente.
- No incluye foco.
- E27



CLAVE	TENSIÓN	WATTS	COLOR
XLA-ES-RJ	127V	40 W	ROJO

LÁMPARA DE ESCRITORIO

- Figura búho.
- Flexible.
- Luz incandescente.
- No incluye foco.
- E27



CLAVE	TENSIÓN	WATTS	COLOR
XLA-BH-NG	127 V	40 W	NEGRO

LÁMPARA DE ESCRITORIO

- Figura búho.
- Flexible.
- Luz incandescente.
- No incluye foco.
- E27



CLAVE	TENSIÓN	WATTS	COLOR
XLA-BH-BC	127V	40 W	BLANCO

POLÍTICAS DE CRÉDITO Y COBRANZA

- Todos los pedidos serán autorizados por el departamento de Crédito y Cobranza.
- Los precios de la lista son unitarios y son base para los descuentos otorgados.
- Estos son L.A.B. en la zona metropolitana del DF.
- El monto mínimo de compra aceptada por la empresa es de \$5,000.00
- A estos precios se les debe incrementar el impuesto al valor agregado (I.V.A.) vigente.
- La mercancía va asegurada por **Productora Metálica, S.A de C.V.**, por lo que la firma al transportista da por aceptado de conformidad el recibo completo del embarque.
- No se aceptan devoluciones sin previa autorización de la empresa. Estas tendrán un cargo del 20% por gastos administrativos.
- Todos los productos fabricados y comercializados por **Productora Metálica, S.A. de C.V.** están garantizados, por lo que podrá reemplazar el producto en mal estado por defecto de fabricación no de instalación, esta será a través de nuestro ejecutivo de cuenta exclusivamente, para que le proporcione la "nota de servicio" correspondiente. Este documento le servirá para comprobar ante la empresa sobre la entrega de la devolución en tiempo y forma.
- **Productora Metálica, S.A. de C.V.**, otorga a sus distribuidores 30 días de crédito sin ningún descuento financiero, para ello siempre se tomará como referencia la fecha de embarque o entrega.
- **AGRADECEMOS NO HACER PAGOS EN EFECTIVO** y seguir los lineamientos legales de la SHCP, expidiendo el cheque cruzado a nombre de **Productora Metálica, S.A. de C.V.** y conteniendo la leyenda "**PARA DEPÓSITO EN CUENTA DEL BENEFICIARIO**".
NO NOS HACEMOS RESPONSABLES POR PAGOS EN EFECTIVO.

- Elemento mínimo de compra para el pago de flete es de \$25,000.00 + IVA
- Para asegurar el pago de sus facturas en tiempo, agradeceremos no esperar la visita del ejecutivo de cuenta y depositar a nombre de Productora Metálica, S.A. de C.V. a las cuentas concentradoras:

Banco	Sucursal	Cuenta	Clabe interbancaria de 18 dígitos
Bancomer	6343	00152606186	012180001526061867
HSBC	669	4010812501	021180040108125018
Banamex	105	742292	002180010507422921
Banamex	870	533302 (referenciado)	002180087005333024
Scotiabank	006	5079845	044180001050798454

y como número de referencia usar el Número de Folio de su Factura.

- Sólo se entregan productos dentro de su empaque colectivo, por seguridad del embarque así como para evitar el maltrato del producto.
- Toda devolución de cheque por pago de alguna factura tendrá un cargo similar al realizarlo a nuestra empresa por el banco. También anula descuentos por pronto pago que se hayan efectuado a esta liquidación.
- Sólo se podrán comercializar los artículos de Productora Metálica, S.A. de C.V. a negocios que estén debidamente registrados y cuenten con su cédula de identificación fiscal.
- La empresa requiere que los pedidos estén firmados por el cliente.
- Los precios están sujetos a cambios sin previo aviso.



NUESTROS CERTIFICADOS



Hualquilla No. 207, Col. Granjas San Antonio, Alcaldía Iztapalapa, C.P. 09070 CDMX

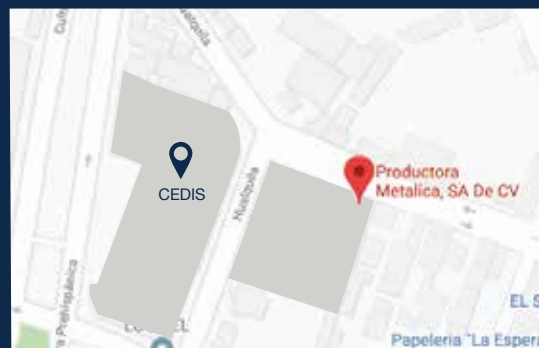



@ProductoraMetalica



@Alfa_Metalica



alfa.productorametalica



AlfaProductoraMetalica



Productora Metálica S.A. de C.V.
Hualquilla No. 207, Col. Granjas San Antonio,
Alcaldía Iztapalapa, C.P. 09070, CDMX



Tel. +52 (55) 5445 2532
Lada sin costo: 01 800 000 ALFA (2532)



www.alfamx.com